

MECHAN CONTROLS



Installation Guide : MS6, MS6-SS, MS21, MS21-SS Safety Switches



Description:

MAGNASAFE safety switches are non-contact, magnetically operated switch and actuator, suitable for use in machine guarding applications.

Magnasafe Safety switches are designed to be used in part of safety related control system. A risk assessment should take place to establish that the specifications of these safety switches are suitable for the application required.

See Technical Specifications below or contact Mechan Controls for further information.

Keep this guide for future reference This information is designed to help suitably qualified personnel install and operate Mechan Safety equipment. Before using this product, read this guide thoroughly along with any relevant European and/or National standards e.g. Machinery Directive 2006/42/EC and it's amendments, Provision and Use of Work Equipment Regulations. Further information can be obtained from Mechan Controls.

Technical Specifications	MS6	MS21	
Contacts	Maximum 2 x NO + 1 x NC	Maximum 2 x NO + 1 x NC	
Safety Contact Rating	230Vac / 2Amps, 110Vac / 3Amps or 24Vdc / 1 Amp	230Vac / 2Amps or 24Vdc / 1 Amp	
Safety Contact Switching	10mm ON / 28mm OFF	10mm ON / 28mm OFF NOTE : MS21-SS-ACT-SP - Special Actuator (for improved performance on ferrous metal applications)	
Auxiliary Contact Rating	15W / 10VA	15W / 10VA	
Auxiliary Contact Switching	11mm OFF / 21mm ON	11mm OFF / 21mm ON	
Internal Fuse	230Vac - 2 Amps / 110Vac - 3Amps / 24Vdc - 1 Amp	230Vac - 2 Amps / 24Vdc - 1 Amp	
External Fuse Fast Acting (Customer supplied)	230Vac - 1.6 Amps 24Vdc - 800mA	230Vac - 1.6 Amps 24Vdc - 800mA	
Construction	RED ABS, or 316 Grade Stainless Steel	RED ABS, or 316 Grade Stainless Steel	
Mechanical Life	10 x 10 ⁶	10 x 10 ⁶	
Electrical Life	1 x 10 ⁶	1 x 10 ⁶	
Shock	30g, 11ms IEC 68-2-27	30g, 11ms IEC 68-2-27	
Vibration	10 - 50Hz IEC 68-2-6	10 - 50Hz IEC 68-2-6	
Operating Temperature (High Temp)	-25°C to +55°C (HT -25°C to +125°C)	-25°C to +55°C (HT -25°C to +125°C)	
IP Rating	IP67	IP67	
Fixing	M4 Torx security screws (Tightening Torque 1.0NM)	M4 Torx security screws (Tightening Torque 1.0NM)	
Connection	Pre-wired or M12 Quick Disconnect	Pre-wired or M12 Quick Disconnect	
Safety Related Data			
B10d	2,000,000	PFH	6.52 x 10 ⁻⁸
TM (Mission Time)	> 20 Years	DC	99%
PFHd	4.3 x 10 ⁻⁸ See Note 1	SFF	98%
MTTFd	High > 100 Years (Based on usage rate of 360 Days/Year, 24 Hours/Day, 10 Operations/Hour)		
Note 1	Based on dual channel wiring according to CAT 3. Diagnostic coverage provided by downstream control logic. DC - medium, MTTFd = 100 Years May be suitable for performance level applications PLe according to ISO 13849-1. (SIL 3 or SIL 2 according to IEC 62061)		
Safety Standards			
Approvals	CE Complies with all relevant sections of the CE Marking Directive UL 508 Industrial Control TUV Approved		
European Directives	Machinery Directive 2006/42/EC, Low Voltage Directive 2006/95/EC; EMC Directive 2004/108/EC		
European Standards	BS EN 12100 Safety of Machinery. General principles for design. BS EN ISO 14119 Safety of Machinery. Interlocking devices associated with guards. Principles for design and selection. BS EN ISO 13849 Safety of Machinery. Safety related parts of control systems. BS EN ISO 62061 Safety of Machinery. Functional safety of safety related electrical, electronic and programmable electronic control systems BS EN 60204 Safety of Machinery. Electrical equipment of machines. BS EN 60947-5-1 Low-voltage switchgear and controlgear. BS EN 60947-5-3 Low-voltage switchgear and controlgear.		

Dimensions

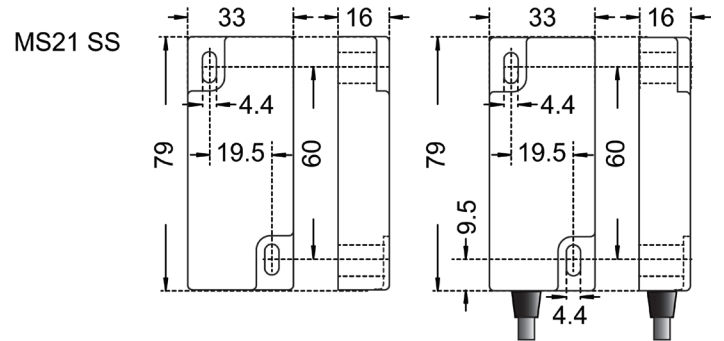
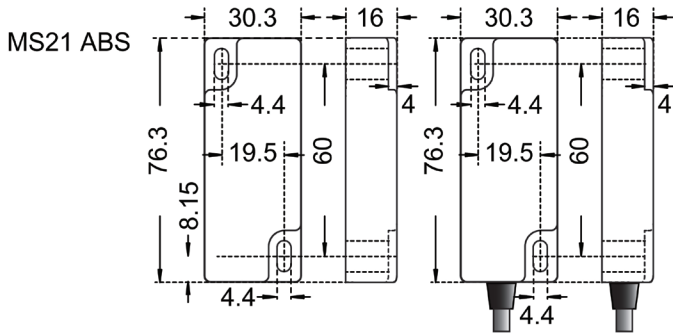
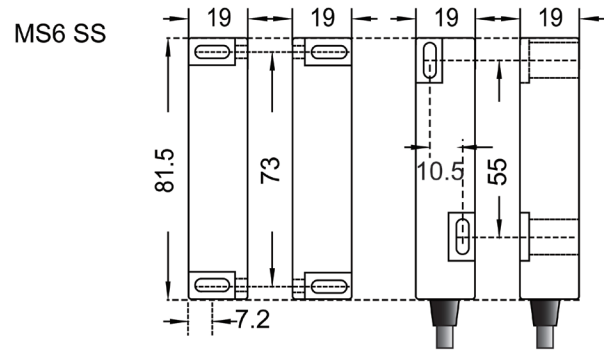
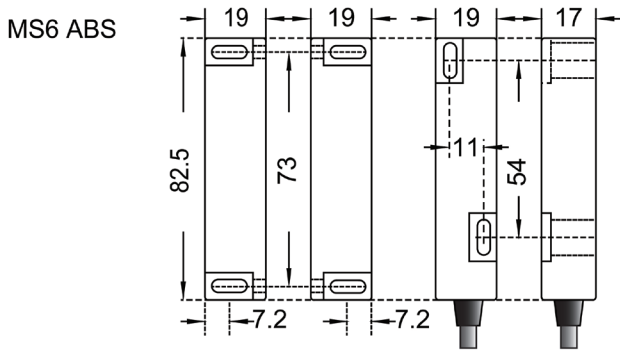

M12 QUICK DISCONNECT OPTION

Switch with M12 connector
MS6/MS6-SS/MS21/MS21-SS

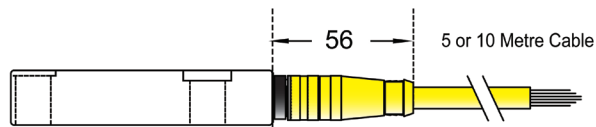

All Dimensions in MM

Operation

Mechan Magnasafe safety switches can approach each other from most directions. When closed the targets printed on the front face of the switches must be aligned (large target to large target and small target to small target as shown above)

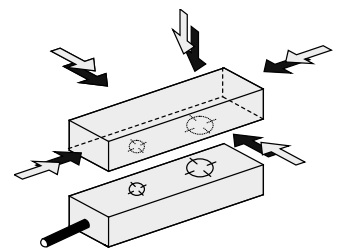
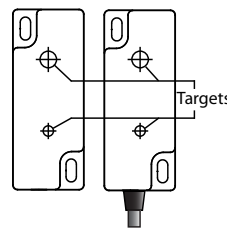
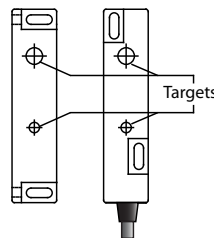

Mounting

Do not use safety switches as a stop. 1 mm separation when closed provides the best results.

Minimum separation 50mm between adjacent switches.

DO NOT mount on hinged side of the guard.

EN1088 : Hide the actuator where possible.

Mount the switch on to the machine frame and the actuator on to the opening edge of the door.

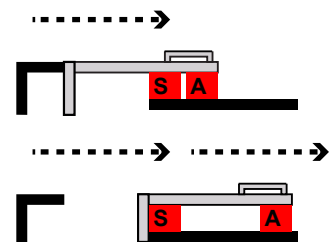
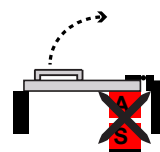
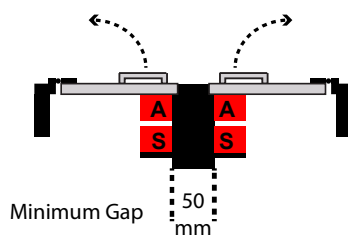

Always try to mount the switch on non-ferrous material. (Ferrous materials may reduce the switching distance.)

NOTE : MS21-SS-SP-ACT

If mounting switch and actuator on ferrous metal using the MS21-SS-SP-ACT actuator may improve the switching performance (Actuator has red encapsulation)

Connections and Fuses

PRE-WIRED

MS6-10 (ac&dc)
MS6-10 (110ac)
MS6-SS-10 (dc)

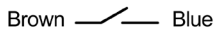

MS6-11 (ac&dc)
MS6-SS-11 (dc)
MS21-11 (ac&dc)

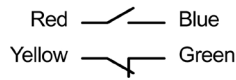

MS6-20 (ac&dc)
MS6-SS-20 (dc)
MS21-20 (ac&dc)

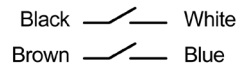

MS6-21 (ac&dc)
MS6-SS-21 (dc)
MS21-21 (ac&dc)

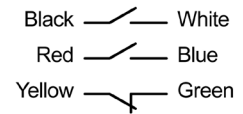

MS6-SS-10 (ac)

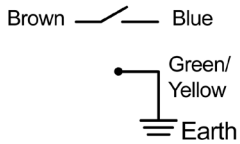

MS21-SS-11 (ac&dc)

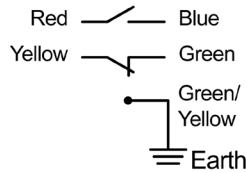

MS21-SS-20 (dc)

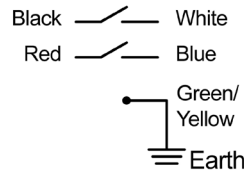

MS21-SS-21 (ac&dc)

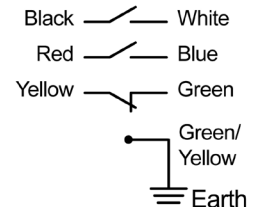

QUICK DISCONNECT

MS6-10 (ac&dc)

Connector Contact Cable

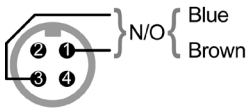

Connector
Micro DC M12

MS6-11 (ac&dc)
MS6-SS-11 (dc)
MS21-11 (ac&dc)

Connector Contact Cable

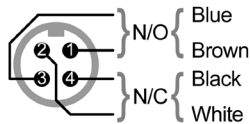

Connector
Micro DC M12

MS6-20 (ac&dc)
MS6-SS-20 (dc)
MS21-20 (ac&dc)

Connector Contact Cable

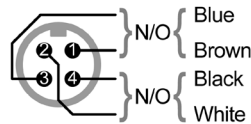

Connector
Micro DC M12

MS6-21 (ac&dc)
MS6-SS-21 (dc)
MS21-21 (ac&dc)
MS21-SS-21 (dc)

Connector Contact Cable

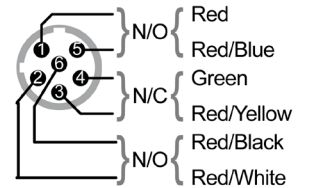

Connector
Micro AC 1/2" - 20

MS6-SS-10 (ac)

Connector Contact Cable

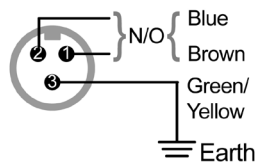

Connector
Micro DC M12

Contact Operation	The N/O contacts on the Mechan switches are open when the actuator is away from the switch. When the actuator is within the specified operating distance the N/O contact will close and the N/C contact will open.
Fuses	All safety contacts should be fused externally AC CONTACTS = 1.6 Amps Quick Blow Fuse (MS6-10-110AC = 3 Amps Quick Blow Fuse) DC CONTACTS = 0.8 AMPS Quick Blow Fuse

Switching Characteristics

MS6

MS21

The chart shows the switching points in millimetres.

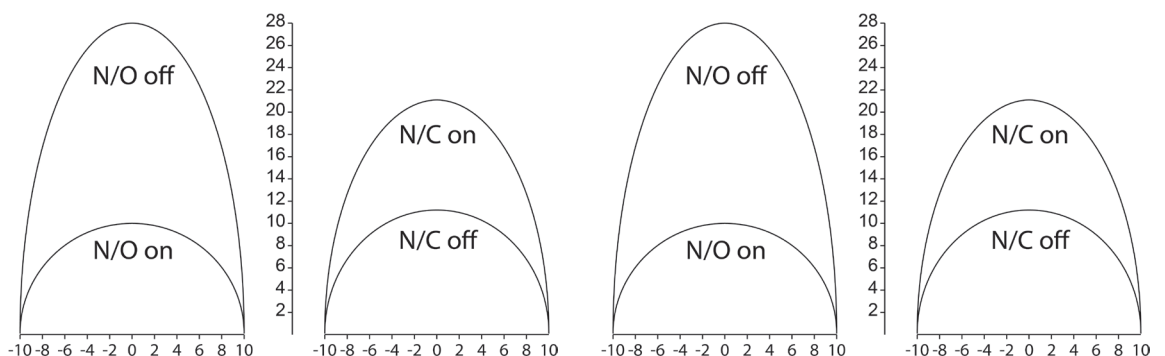

Recommended Safety Control Unit

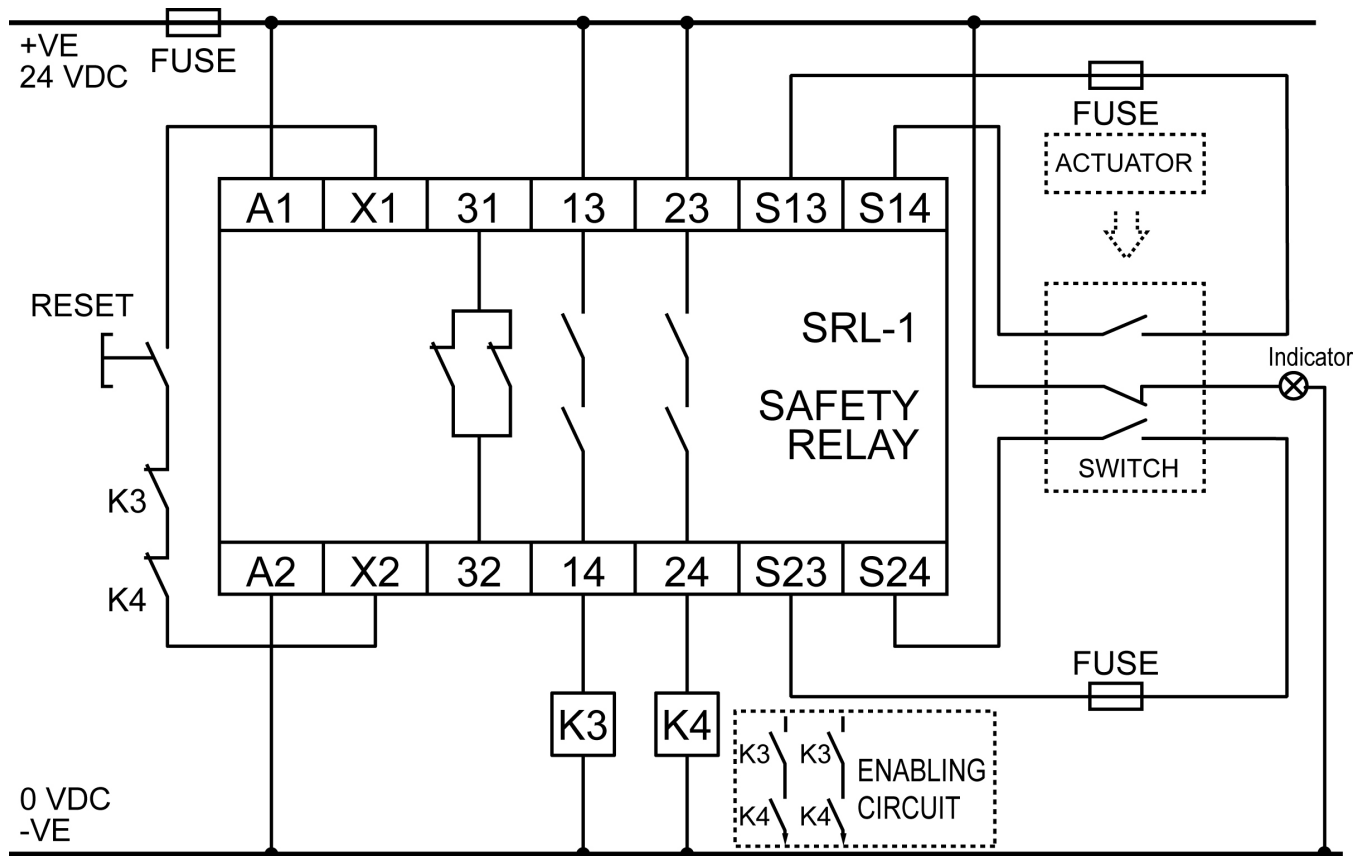

Recommended Safety Control Unit

Mechan Part Number : SRL-1 24VAC/DC

Maintenance

It is recommended to check the safe operation of the of the switches and look for signs of damage or excessive wear on a weekly basis. Damaged units should be replaced or returned to the manufacturer for repair where practical.

Declaration of Conformity

Mechan Controls declares that the products shown conform to the Essential Health and Safety Requirements of the European Machinery Directive. The above products have been third party tested to conform to the requirements of EN-13849-1 and EN 62061. Full declaration of conformity can be downloaded from the Mechan Controls web site www.mechancontrols.co.uk or by contacting Mechan directly Tel : + 44 1695 722264

NOTES

In the interest of product development specifications are subject to change without notice. It is the responsibility of the user to ensure compliance with any acts or by-laws in place. All information regarding Mechan equipment is believed to be accurate at the time of printing. Responsibility cannot be accepted for errors or omissions.

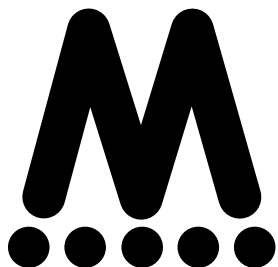

MECHAN CONTROLS PLC

14/16 SEDDON PLACE, STANLEY INDUSTRIAL ESTATE
SKELMERSDALE, LANCASHIRE WN8 8EB
UNITED KINGDOM

Telephone :+44(0)1695 722264

Web : www.mechancontrols.co.uk

Document Number 350-402-ID1rev5