

PRODUCT CATALOG



TABLE OF CONTENTS

Pressure and vacuum sensors

Various models, high accuracy, compact and reliable

Pressure and vacuum switches

Pressure and vacuum switches with transistor switching output

6

Summary

All pressure and vacuum switches at a glance

14

Pressure and vacuum transmitters

Pressure / vacuum transmitters with an analog current or voltage output

16

Inclination switches

Precise and robust, with transistor switching output or relay output

20

Summary

All inclination switches at a glance

24

Vacuum ejectors

Economical, fast and reliable vacuum ejectors in various models

26

Accessories

Suitable accessories such as cables, brackets, adapters, ...

34



MP-SENSOR & NORSTAT

Your partners for innovative sensors, automation and safety

MP-SENSOR GmbH : A family-owned, German Company that develops, manufactures and effectively distributes high-quality sensors and switches to a world-wide customer base. MP-Sensor, quality products proudly made in Germany!

Our Strength : Expertly designed and developed products, both proprietary and customer-specific. We implement the latest technologies in sensor functionality which contributes to the success of our company as well as our customers.

Our Products : All of our products are excellently suited for applications in the areas of robotics, material handling (vacuum lifting technology), mobile machines as well as general plant use, machine construction and automation.

NORSTAT : With almost 60 years of experience in the Safety and Automation marketplace Norstat, Inc. is the Exclusive North American Master Distributor of MP-Sensor products.

Since 1962 : With almost 60 years of experience in the Safety and Automation marketplace Norstat, Inc. is the Exclusive North American Master Distributor of MP-Sensor products.

Trained Engineering Staff : Whether it's in their Rockaway, New Jersey headquarters or out in the field close to the customer, Norstat's trained staff can offer expert solutions for all your safety and automation requirements.

Get Safe... Get Automated.

PRESSURE & VACUUM SWITCHES

Electronic vacuum and pressure switches with digital transistor switching outputs

MP-SENSOR pressure and vacuum switches excel with extraordinary quality and the most compact and robust design. All switches are available with PNP or NPN transistor switching outputs and are designed for industrial continuous operation.

Together with the switching signal, many sensors can also output additional information through the IO-Link functionality such as the actual pressure value. This and many more functions are possible with the new IO-Link technology, which is available for almost all MP-SENSOR products.

CASES OF APPLICATIONS

Due to the very compact size and light weight, MP-SENSOR pressure and vacuum switches are especially eligible for applications in the robotic and handling area (vacuum lifting), as well as for general purposes in machine and plant engineering. Basically anywhere a reliable pressure or vacuum switch is required. Amongst other cases of applications, our switches are often used for controlling vacuum pumps or are integrated in robotic end-of-arm tools to ascertain a successful tool change on an automatic tool changing system.

PICO-02

Multipurpose pressure and vacuum switch with keypad and rotatable display



rotatable 360° IO-Link

YOUR ADVANTAGES

- + For small spaces: Ø 16 mm
- + Easily programmable: without tools
- + Smart sensor: IO-Link
- + Easy installing: display and buttons rotatable by 360°
- + Quick diagnosis: LEDs / IO-Link
- + Real time pressure reading

CHARACTERISTICS

The PICO-02 switch is controlling actuators directly or indirectly over 2 independently adjustable transistor switching outputs (each supplied with 250 mA), without necessarily needing a control unit (such as a PLC). The light-weight and compact design is predestined for applications in vacuum lifting technology or to control valves. If the PICO-02 is connected to an IO-Link master, it will switch into IO-Link mode. Otherwise the outputs can be used conventionally as signal transmitters or switches.

The PICO-02 is very easily programmable on site by using its keys and display to access the menu. 3 status LEDs and the diagnosis function of IO-Link provide ideal fault diagnosis.

TECHNICAL DATA

Setting options	Hysteresis / window mode, NO/NC, pressure unit, switch points, switching delay for ON and OFF, key lock, display ON/OFF/ROTATE
Pressure ranges (bar); (psi)	-1...0 / -1...1 / -1...10 / 0...10 / 0...12 bar; -14,5...0 / -14,5...14,5 / -14,5...145 / 0...145 / 0...174 psi
Switching outputs	2x PNP or 2x NPN
Operating fluids	Filtered, dry or oiled air and non-corrosive gases
Mounting position	Any (port downwards when using oiled air)
MTTF (40° C)	318 years
Material (housing)	Plastic PC
Material (process connection)	Brass nickel-plated
Operating voltage	11...30 VDC
Accuracy	± 2% FS
Repeatability	± 0,2% FS
IO-Link interface	yes
Electrical connection	M8 4-pole / M12 4-pole

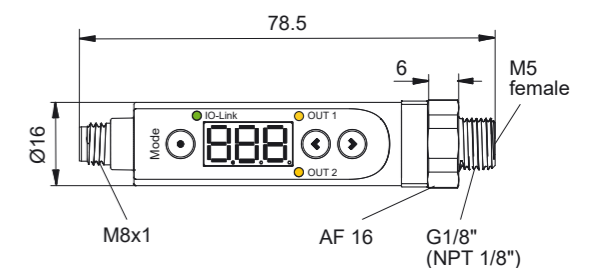

TO SEE ALL OUR PRESSURE AND VACUUM SWITCHES AT A GLANCE, GO TO PAGE 14

VARIANTS / ORDER CODE

Process connection		Pressure range		
G1/8"	02	bar	psi	
NPT1/8"	04	-1...0	-14.5...0	1
		-1...1	-14.5...14.5	2
		-1...10	-14.5...145	3
		0...10	0...145	4
		0...12	0...174	5
Electrical connection				
M8 4-pole	01			
M12 4-pole	02			
Output signal				
2x PNP	03			
2x NPN	04			

NANO-02

Multipurpose pressure and vacuum switch with keypad, display and a durable metal housing



IO-Link

YOUR ADVANTAGES

- + Very narrow: only 33 mm in height
- + Easily programmable: without tools
- + Smart sensor: IO-Link
- + Very robust: metal housing
- + Quick diagnosis: LEDs / IO-Link
- + Real time pressure reading

CHARACTERISTICS

The NANO-02 is predestined for many applications within the pneumatic industry. The durable but compact metal housing enables the use in harsh environmental conditions and the installation in limited spaces. The sensor is equipped with two transistor switching outputs, of which one can be used optionally as an IO-Link communication interface. Through IO-Link functionality, the sensor has got an additional simple option to change and display all parameters.

The NANO-02 is very easily programmable on site by using its keys and display to access the menu. 3 status LEDs and the diagnosis function of IO-Link provide ideal fault diagnosis.

VARIANTS / ORDER CODE

Process connection		Pressure range		
G1/8" female	08	bar	psi	
NPT1/8" male	04	-1...0	-14.5...0	1
		-1...1	-14.5...14.5	2
		-1...10	-14.5...145	3
		0...10	0...145	4
		0...12	0...174	5
Electrical connection				
M8 4-pole	01			
Output signal				
2x PNP	03			
2x NPN	04			

TECHNICAL DATA

Setting options	Hysteresis / window mode, NO/NC, pressure unit, switch points, switching delay for ON and OFF, key lock, display ON/OFF/ROTATE
Pressure ranges (bar); (psi)	-1...0 / -1...1 / -1...10 / 0...10 / 0...12 bar; -14,5...0 / -14,5...14,5 / -14,5...145 / 0...145 / 0...174 psi
Switching outputs	2x PNP or 2x NPN
Operating fluids	Filtered, dry or oiled air and non-corrosive gases
Mounting position	Any (port downwards when using oiled air)
MTTF (40° C)	319 years
Material (housing)	Alloy (anodized)
Material (process connection)	Alloy (anodized)
Operating voltage	11...30 VDC
Accuracy	± 2% FS
Repeatability	± 0,2% FS
IO-Link interface	yes
Electrical connection	M8 4-pole

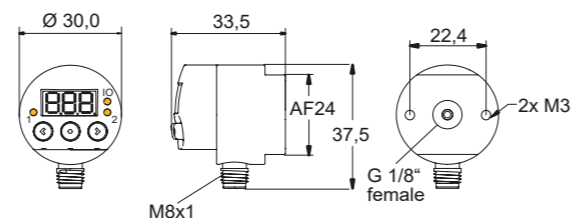

FEMTO

Multipurpose pressure and vacuum switch with a keypad, one switching output and one analog output



rotatable 360°

YOUR ADVANTAGES

- + All-rounder: transistor switching output plus additional analog output
- + Easily programmable: with keypad
- + Very small: Ø 16 mm, 65 mm in length
- + Easy installing: rotatable by 360° after mounting

CHARACTERISTICS

The FEMTO sensor is equipped with an adjustable transistor switching output (supplied with 250 mA) as well as with an analog output. This way the sensor is able to control actuators directly or indirectly and supply an analog measurement signal at the same time. Therefore it can be used in a wide range of the pneumatic field. When installing the FEMTO, the rotatable body ensures a quick alignment and initial setup.

The FEMTO is easily teachable on site by using its 3 keys. LEDs are indicating the status of the output or will assist during teaching.

VARIANTS / ORDER CODE

Process connection		Pressure range		
G1/8"	02	bar	psi	
NPT1/8"	04	-1...0	-14.5...0	1
		-1...10	-14.5...145	3
Electrical connection				
M8 4-pole	01			
M12 4-pole	02			
Output signal				
1x PNP + 1x analog 1...5 V	05			
1x NPN + 1x analog 1...5 V	On request			

TECHNICAL DATA

Setting options	Switch point, hysteresis, NO/NC, reset to factory settings
Pressure ranges (bar); (psi)	-1...0 / -1...10 bar; -14,5...0 / -14,5...145 psi
Outputs	1x PNP plus 1x analog 1...5 V or 1x NPN plus 1x analog 1...5 V
Operating fluids	Filtered, dry or oiled air and non-corrosive gases
Mounting position	Any (port downwards when using oiled air)
Weight	Approx.. 20 g
Material (housing)	Plastic PC
Material (process connection)	Brass nickel-plated
Operating voltage	11...30 VDC
Accuracy	± 2% FS
Repeatability	± 0,2% FS
IO-Link interface	no
Electrical connection	M8 4-pole / M12 4-pole

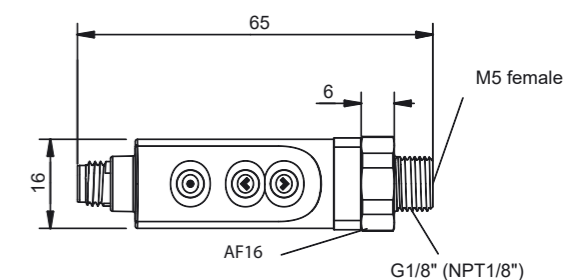

VS11

Miniature vacuum switch for very narrow spaces, with adjustment potentiometer

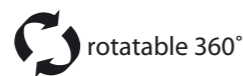

YOUR ADVANTAGES

- + Miniature design: smallest possible size for narrow spaces
- + Potentiometer: switching point is easily adjustable
- + Extremely light-weight: only 8 g
- + Simple installation: continuously rotatable by 360°
- + Male connector or open cable end

CHARACTERISTICS

The trendsetting sensor design of the VS11 is the most light-weight and smallest possible size available today. Specifically designed for extremely narrow spaces and simple installation, the fluid port comes either with an M5 thread or a tube connection. The options for the electrical connection are an M8 male connector or an attached cable with an open cable end. Once installed, the sensor is still rotatable by 360°, which ensures a quick and simple initial setup.

 The switch point of the VS11 is easily settable on site by using its adjustment potentiometer. 2 LEDs are indicating the status of operation and the switching status.

VARIANTS / ORDER CODE

Process connection		Pressure range	
M5 male	01	bar	psi
Tube Ø 4 mm	06	-1...0	-14.5...0
		-1...1	-14.5...14.5
Electrical connection		Output logic	
3 m cable	04	NO	1
M8 3-pole	05	NC	2
Output signal			
1x PNP	01		

TECHNICAL DATA

Setting options	Switching point with adjustment potentiometer
Pressure ranges (bar); (psi)	-1...0 / -1...1 bar; -14.5...0 / -14.5...14.5 psi
Switching outputs	1x PNP (NPN on request)
Operating fluids	Filtered, dry or oiled air and non-corrosive gases
Mounting position	Any (port downwards when using oiled air)
Weight	8 g
Material (housing)	Plastic PC
Material (process connection)	Brass nickel-plated
Operating voltage	9...30 VDC
Accuracy	± 2% FS
Repeatability	± 0,2% FS
IO-Link interface	no
Electrical connection	M8 3-pole / open cable end

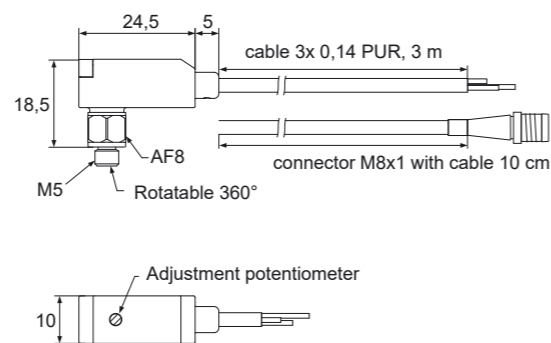

F08-K

Very compact and light-weight pressure and vacuum switch with IO-Link interface



YOUR ADVANTAGES

- + For small spaces: only Ø16 mm, only 45 mm in length
- + When every gram counts: 18 g
- + Smart sensor: IO-Link interface
- + Tube connection possible

CHARACTERISTICS

The F08-K is a small and light-weight pressure and vacuum switch. It is especially suitable for applications within the pneumatic field, where size and weight matter, but still a smart sensor with many setting options is required. The F08-K can be programmed by its IO-Link interface. If no IO-Link is needed, the sensor can of course be used as a conventional switch with the transistor switching output.

 Additionally to the G1/8" fluid port, there is also a 6mm tube connection available for a simple and quick adaption to vacuum.

VARIANTS / ORDER CODE

Process connection		Pressure range	
G1/8"	02	bar	psi
NPT1/8"	04	-1...0	-14.5...0
Tube 6 mm	05	-1...1	-14.5...14.5
		-1...10	-14.5...145
		0...10	0...145
		0...12	0...174
Electrical connection			
M8 4-pole	01		
M12 4-pole	02		
Output signal			
1x PNP	01		
1x NPN	02		

TECHNICAL DATA

Setting options	Hysteresis / window mode, NO/NC, switch points, switching delay for ON and OFF, reset to factory settings
Pressure ranges (bar); (psi)	-1...0 / -1...1 / -1...10 / 0...10 / 0...12 bar; -14,5...0 / -14,5...14,5 / -14,5...145 / 0...145 / 0...174 psi
Switching outputs	1x PNP or 1x NPN
Operating fluids	Filtered, dry or oiled air and non-corrosive gases
Mounting position	Any (port downwards when using oiled air)
Weight	Approx. 18 g
Material (housing)	Plastic PC
Material (process connection)	Brass nickel-plated
Operating voltage	11...30 VDC
Accuracy	± 2% FS
Repeatability	± 0,2% FS
IO-Link interface	yes
Electrical connection	M8 4-pole / M12 4-pole

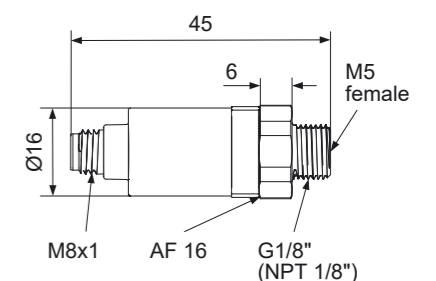

F08-M1

Precise, compact and durable pressure and vacuum switch with a stainless steel housing and one switching output



LABS_{free} IO-Link

YOUR ADVANTAGES

- + Extremely robust and durable for robotics, handling, packaging. Vibration / shock, LABS-free, stainless steel
- + 1 transistor switching output
- + Smart sensor: IO-Link
- + For small spaces: Ø 16 mm
- + Customer variants are done quickly

CHARACTERISTICS

The F08-M1 convinces by its special suitability in demanding environments. This pressure and vacuum switch in a stainless steel housing is tested to its high vibration/shock load capability. The compact and extremely robust design predestines the F08-M1 e.g. for applications in robotics. The proven and at "Fraunhofer Institute" according to the newest VDMA standard tested fact, that the sensor is LABS-free, makes it perfectly suitable for applications within lacquering system lines.

⚡ If the F08-M1 is connected to an IO-Link master, it will switch into IO-Link mode, which will enable extensive programming options. Otherwise the output can be used conventionally as a signal transmitter or a switch.

VARIANTS / ORDER CODE

Process connection		Pressure range		
G1/8"	02	bar	psi	
G1/4"	03	-1...0	-14.5...0	1
NPT1/8"	04	-1...1	-14.5...14.5	2
Push-in 6 mm	07	-1...10	-14.5...145	3
G3/8"	09	0...10	0...145	4
		0...12	0...174	5
Output signal				
1x PNP	01			
1x NPN	02			

TECHNICAL DATA

Setting options	Hysteresis / window mode, NO/NC, switch points, switching delay for ON and OFF, reset to factory settings
Pressure ranges (bar); (psi)	-1...0 / -1...1 / -1...10 / 0...10 / 0...12 bar; -14,5...0 / -14,5...14,5 / -14,5...145 / 0...145 / 0...174 psi
Switching outputs	1x PNP or 1x NPN
Operating fluids	Filtered, dry or oiled air and non-corrosive gases
Mounting position	Any (port downwards when using oiled air)
MTTF (40° C)	820 years
Material (housing)	Stainless steel 1.4305
Material (process connection)	Brass nickel-plated
Operating voltage	9...30 VDC
Accuracy	± 2% FS
Repeatability	± 0,2% FS
IO-Link interface	yes
Electrical connection	M12 4-pole

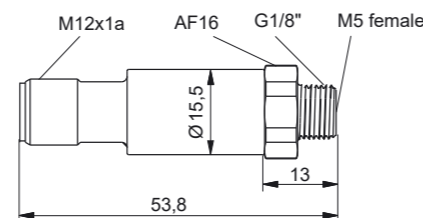

F08-M2

Precise, compact and durable pressure and vacuum switch with a stainless steel housing and two switching outputs



LABS_{free} IO-Link

YOUR ADVANTAGES

- + Extremely robust and durable for robotics, handling, packaging. Vibration / shock, LABS-free, stainless steel
- + 2 transistor switching outputs
- + Smart sensor: IO-Link
- + For small spaces: Ø 16 mm
- + Customer variants are done quickly

CHARACTERISTICS

The F08-M2 convinces by its special suitability in demanding environments. This pressure and vacuum switch in a stainless steel housing is tested to its high vibration/shock load capability and is proven to be LABS-free. It comes with two independently programmable transistor switching outputs (each supplied with 250 mA). The compact and extremely robust design predestines the F08-M2 for applications in robotics, lacquering systems, handling, packaging, ...

⚡ Through its IO-Link communication interface, the F08-M2 is enabled with extensive programming options. Amongst other settings, the switch point, re-switch point or the switching logic can be changed.

VARIANTS / ORDER CODE

Process connection		Pressure range		
G1/8"	02	bar	psi	
G1/4"	03	-1...0	-14.5...0	1
NPT1/8"	04	-1...1	-14.5...14.5	2
Push-in 6 mm	07	-1...10	-14.5...145	3
G3/8"	09	0...10	0...145	4
		0...12	0...174	5
Output signal				
1x PNP	01			
1x NPN	02			

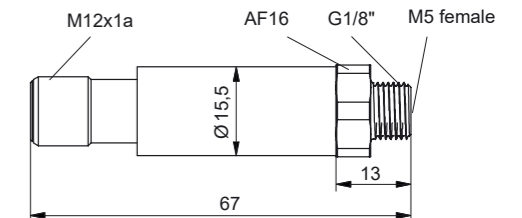

TECHNICAL DATA

Setting options	Hysteresis / window mode, NO/NC, switch points, switching delay for ON and OFF, reset to factory settings
Pressure ranges (bar); (psi)	-1...0 / -1...1 / -1...10 / 0...10 / 0...12 bar; -14,5...0 / -14,5...14,5 / -14,5...145 / 0...145 / 0...174 psi
Switching outputs	2x PNP or 2x NPN
Operating fluids	Filtered, dry or oiled air and non-corrosive gases
Mounting position	Any (port downwards when using oiled air)
MTTF (40° C)	713 years
Material (housing)	Stainless steel 1.4305
Material (process connection)	Brass nickel-plated
Operating voltage	9...30 VDC
Accuracy	± 2% FS
Repeatability	± 0,2% FS
IO-Link interface	yes
Electrical connection	M12 4-pole

P.TOUCH

Industrial pressure sensors with IO-Link / 0...600 bar



SIMPLE & SMART



Using the TFT touch-screen, 2 PNP switching outputs can be set quickly and conveniently with a virtual scroll wheel.



Further setting parameters and extensive diagnostic options can be operated and called up both directly on the display and via the integrated IO-Link interface.

SMALL & ROBUST

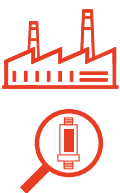

One of the smallest sensors with integrated display and yet extremely robust. The housing with protection class IP67 is made of solid stainless steel and designed for continuous industrial operation.

DOUBLE PATENTED* TOUCH-DISPLAY

- TFT Touch-Display
Innovative, unique operating concept
- 350° rotatable after installation
Easy display alignment
- Break-proof design
Patented* display integration
- Virtual scroll wheel
Patented* adjustment of switching points

VARIABLY APPLICABLE

- Ultra compact - ø27mm / 67mm long
- 0-600 bar - Liquid, gaseous and viscous fluids
- 0.5% FSO accuracy, incl. non-linearity, non-repeatability and hysteresis
- 2 switching outputs – 1x PNP + 1xPNP / IO-Link
- 1 analog output – 4-20 mA
- The P.TOUCH is ideally suited for a wide range of applications, e.g. for controlling the pressure in hydraulic systems, monitoring the cooling lubricant supply or process pressure measurement on injection molding machines.

CREATED FOR INDUSTRY 4.0

*patent pending

DATA SHEET | ENGLISH



Industry 4.0 ready IO-Link sensor with TFT touch screen and a new, innovative operating concept.

Ultra-compact design for use in the tightest of spaces.

Fully configurable outputs (switching output / analog / IO-Link).

Extended display and diagnostics options through 160x80px display.

Virtual, dual scroll wheel.

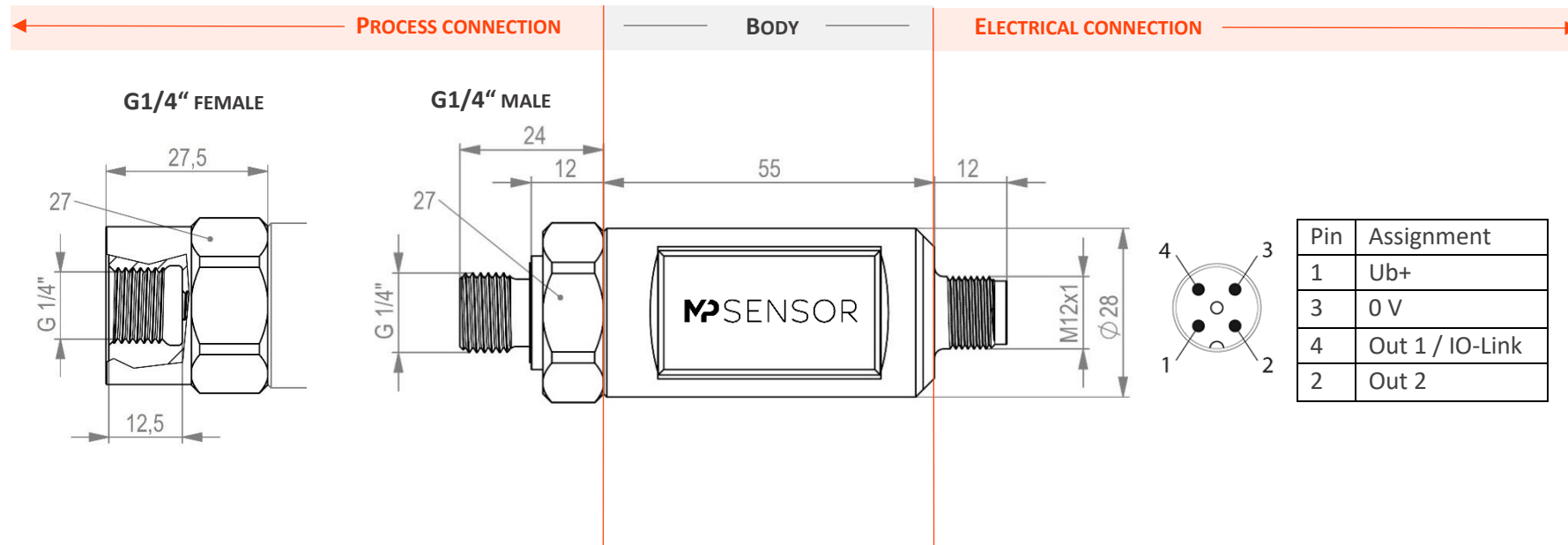

General data

Display	0,96" TFT touch display, breakproof installation
Switching status display	1x color indication per OUT
IO-Link status display	color display
Protection class rating	IP65 / IP67 / IP68
Protection level	III
Expected lifetime	100 Mio. load changes
Pressure type	relative pressure
Measuring cell type	ceramic
MTTF (40°C)	478 years (continuous operation)

Ordering information

5 - 10 - X 1 3 X - XXX 0 XX

<i>Process connection</i>			<i>Firmware</i>	
G1/4" M (male)	1		Standard	00
G1/4" F (female)	5		Customized	>00
<i>Sealings</i>			<i>Pressure range*</i>	
NBR (=standard)	1	0...10 bar		010
FKM	2	0...16 bar		016
EPDM	3	0...25 bar		025
		0...40 bar		040
		0...100 bar		100
		0...250 bar		250
		0...400 bar		400
		0...600 bar		600

**more pressure ranges available on request*

Electrical data

Electrical connection	Connector M12x1, 4-pole
Operating voltage	9...30 VDC
Current consumption [Ub]	< 30 mA
Short-circuit / reverse polarity prot.	yes / yes

Output

Out 1 (Pin 4)	PNP/NPN/PP or IO-Link
Out 2 (Pin 2)	PNP/NPN/PP or analog (0-10V / 1-10V / 4-20mA)
Max. output current	max. 200 mA per output
Output voltage	Ub - 2,0V
Response time	< 3 ms

Accuracy

Total accuracy (23°C)	± 0,5% FS (LP)
max. temperature error (-25...+80°C)	± 1,5% FS (<100bar); ± 2,5% (≥100bar)
Long-term drift	≤ 0,1% FS / a

Programming options

Outputs	Switching/re-switching points; start/end value for analog output; hysteresis/window mode; normally closed/ normally open contact; switch-on/switch-off delay
Display	Display mode (simple / detail. / off); color behavior; rotation; brightness; update rate; screen lock
Measuring value	Units; Damping; Resolution

Diagnosis

Pressure peaks	Counter, adjustable threshold, reset
Counters	Switching operations; load changes; operating hours; starting cycles

Materials (wetted parts)

Material fluid connection	stainless steel 1.4404
Material measuring cell	ceramic Al ₂ O ₃ 96%
Material seals	see ordering information

Materials (non-wetted parts)

Material housing	stainless steel 1.4301
Material display	glass (breakproof installation)
Sealing display	PE

Mechanical data

Wrench size pressure connection	27
Weight	191g (G1/4" M); 244g (G1/4" F)

Pressure range

Measuring range [bar]	10	16	25	40	100	250	400	600
Overload press.** [bar]	20	40	40	100	150	375	500	750
Burst pressure** [bar]	35	60	60	140	300	500	650	900

*** increased overload resistance available on request*

Operating conditions

Operating temperature	Operation: -25°...+80°C*** Fluid: -25°...+100°C***
Range of application	Storage: -30°...+85°C Fluid group 2 media only
EMC / interference immunity	EN61000-6-2 and EN61326-2-3
EMC / interference emission	EN61000-6-4 and EN61326-2-3
Vibration resistance	DIN EN 60068-2-6: 20G, 10-2000 Hz, XYZ
Shock resistance	DIN EN 60068-2-27: 50G, 11ms, XYZ

****display will turn off at display temperature of 80°C*

P.TRACE

Industrial pressure transducers / 0...600 bar



ACCURATE & COMPATIBLE



The high accuracy and short response time of the pressure transducer are permanently guaranteed by the high long-term stability of the ceramic measuring element.



Various analog signals such as 0-10V / 1-10V or 4-20mA can be picked up by means of the popular standard industrial plug connection, the M12 4-pole..

SMALL & ROBUST



One of the smallest sensors with a ceramic measuring element and yet extremely robust. The housing with protection class IP67 is made of solid stainless steel and designed for continuous industrial operation.

FOR TIGHTEST REQUIREMENTS

Fully stainless steel housing completely made of 1.4404 / 1.4301

E-connection M12 4-pin
Established M12 plug connection

Short response time
Fast response through direct signal processing

High long-term stability
Through high-quality ceramic measuring element

VARIABLY APPLICABLE

Ultra compact - ø24mm / 33mm long
0-600 bar - Liquid, gaseous and viscous fluids

0.5% FSO accuracy, incl. non-linearity, non-repeatability and hysteresis

1 analog output - 0-10V, 1-10V or 4-20mA

The P.TRACE is ideally suited for a wide range of applications, e.g. monitoring the pressure in hydraulic circuits, ensuring the coolant supply in thermal processes or determining the process pressure in industrial plants in a wide variety of industries.

CREATED FOR THE INDUSTRY

DATA SHEET | ENGLISH



One of the smallest sensors with ceramic measuring cell and yet extremely robust. The housing with IP68 protection class is made of solid stainless steel and designed for continuous industrial use.

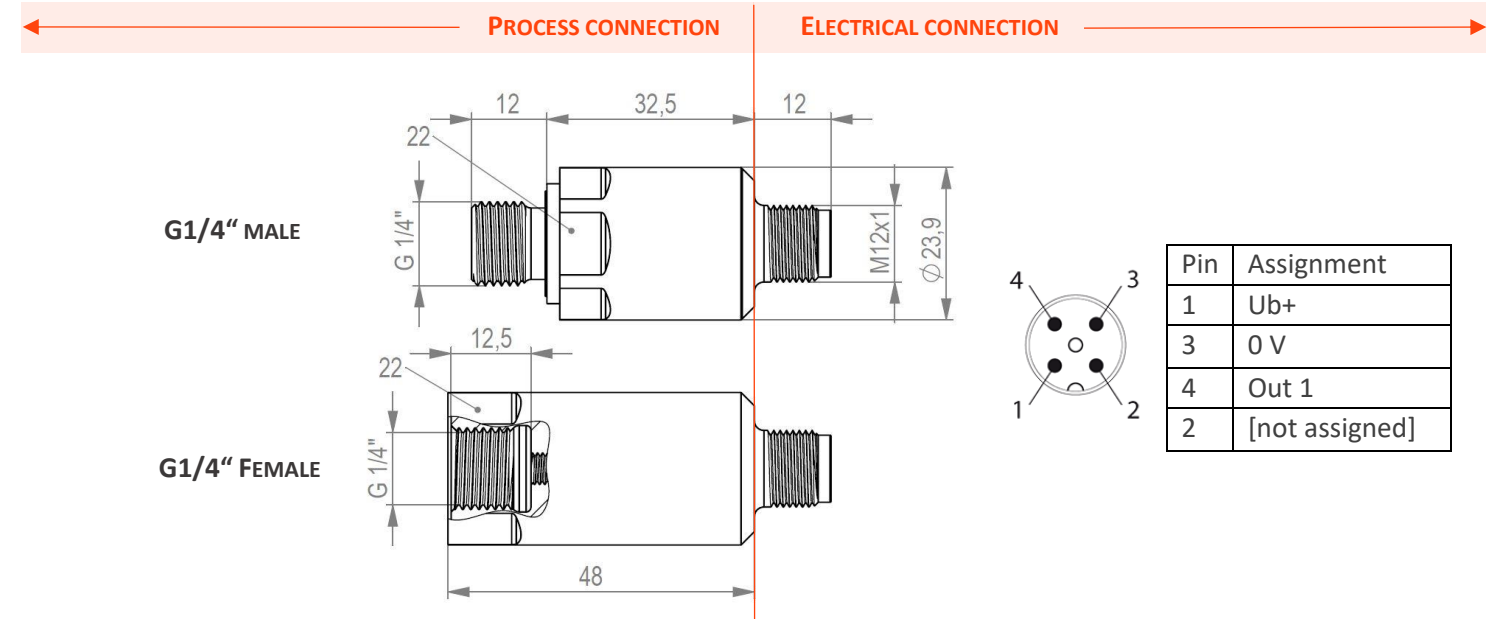

General data	
Protection class rating	IP65 / IP67 / IP68
Protection level	III
Expected lifetime	100 Mio. load changes
Pressure type	relative pressure
Measuring cell type	ceramic
MTTF (40°C)	2.236 years (continuous operation)

Ordering information	
5 - 30 - X 1 X X - XXX 0 XX	
<i>Process connection</i>	<i>Firmware</i>
G1/4" M (Außen) 1	Standard 00
G1/4" F (Innen) 5	Kundenspezifisch >00
<i>Output signal</i>	<i>Pressure range*</i>
0-10V 5	-1...5bar 005
1-10V 6	0...10 bar 010
4-20mA 7	0...16 bar 016
	0...25 bar 025
	0...40 bar 040
	0...100 bar 100
	0...250 bar 250
	0...400 bar 400
	0...600 bar 600
<i>Sealings</i>	
NBR (=Standard) 1	
FKM 2	
EPDM 3	

*more pressure ranges available on request

Mechanical data	
Process connection	G1/4" M, G1/4" F
Wrench size pressure connection	22
Weight	68g (G1/4" M); 103g (G1/4" F)

Electrical data	
Electrical connection	Connector M12x1, 4-pole
Operating voltage [U _b]	9...30 VDC (13...30 VDC for voltage output)
Current consumption	< 25 mA
Short-circuit / reverse polarity prot.	yes / yes

Output	
Out 1 (Pin 4)	0-10V / 1-10V / 4-20mA
Min. load resistance (0-10V / 1-10V)	2 kΩ
Max. load (4-20mA)	500 Ω
Response time	< 3 ms

Accuracy	
Total accuracy (23°C)	± 0,5% FSO (GP)
max. temperature error (-25...+80°C)	± 1,5% FS (<100bar); ± 2,5% (≥100bar)
Repetition accuracy	± 0,2% FS
Long-term drift	≤ 0,1% FS / a

Materials (wetted parts)	
Material fluid connection / housing	stainless steel 1.4404
Material measuring cell	ceramic Al ₂ O ₃ 96%
Material seals	see ordering information

Materials (non-wetted parts)	
Material connector M12	stainless steel 1.4301 / 1.4305

Pressure range	
Measuring range [bar]	5 10 16 25 40 100 250 400 600
Overload press. ** [bar]	10 20 40 40 100 150 375 500 750
Burst pressure ** [bar]	20 35 60 60 140 300 500 650 900

** increased overload resistance available on request

Operating conditions	
Operating temperature	Operation: -25°...+80°C Fluid: -25°...+100°C Storage: -30°...+85°C
Range of application	Fluid group 2 media only
EMC / interference immunity	EN61000-6-2
EMC / interference emission	EN61000-6-4
Vibration resistance	DIN EN 60068-2-6: 20G, 10-2000 Hz, XYZ
Shock resistance	DIN EN 60068-2-27: 50G, 11ms, XYZ

SUMMARY - PRESSURE AND

The details of all MP-Sensor electronic pressure and vacuum switches at a glance



	PICO-02	NANO-02	FEMTO	VS11
GENERAL DATA				
Pressure ranges (bar); (psi)	-1..0 / -1.1 / -1..10 / 0..10 / 0..12; -14,5..0/-14,5...14,5/-14,5..145/0..145/0..174	-1..0 / -1.1 / -1..10 / 0..10 / 0..12; -14,5..0/-14,5...14,5/-14,5..145/0..145/0..174	-1..0 / -1..10; -14,5...0/-14,5...145	-1..0 / -1.1; -14,5..0/-14,5...14,5
Signaling	3 digit 7 segment display	3 digit 7 segment display	1x LED (programming)	1x LED (operation)
Switching status display	2x LEDs	2x LEDs	1x LED	1x LED
IO-Link	●	●	–	–
IO-Link status display	1x LED	1x LED	–	–
Operating fluids	Filtered, dry or oiled air and non-corrosive gases	Filtered, dry or oiled air and non-corrosive gases	Filtered, dry or oiled air and non-corrosive gases	Filtered, dry or oiled air and non-corrosive gases
Degree of protection	IP65	IP65	IP65	IP40
PROGRAMMING OPTIONS				
Hysteresis / Window mode	● / ●	● / ●	● / –	● / –
Switch point / Reset point	● / ●	● / ●	● / ●	● / hysteresis 5% (fix)
Switching logic NO / NC	● / ●	● / ●	● / ●	● / ● (only preset)
Pressure unit	bar; psi; MPa; kPa, mmHg; inHg	bar; psi; MPa; kPa, mmHg; inHg	–	–
Switching delay ON	●	●	–	–
Switching delay OFF	●	●	–	–
Display rotatable by 180°	●	●	–	–
Display OFF	●	●	–	–
Diagnosis mode	●	●	–	–
Key lock	●	●	–	–
Reset to factory settings	●	●	●	–
ELECTRICAL DATA				
Electrical connection	M8, 4-pole; M12, 4-pole	M8, 4-pole	M8, 4-pole; M12, 4-pole	M8, 3-pole; 3 m cable, open cable end
Operating voltage	10,8...30 VDC	10,8...30 VDC	10,8...30 VDC	9...30 VDC
intrinsic current consumption	< 15 mA / < 3 mA in energy save mode	< 15 mA / < 3 mA in energy save mode	< 30 mA	< 20 mA
Short-circuit protection / Reverse polarity protection	● / ●	● / ●	● / ●	● / ●
OUTPUT				
Switching output	2x PNP; 2x NPN (on request)	2x PNP; 2x NPN (on request)	1xPNP (NPN on request) + 1x analog 1..5 V	1x PNP;
Max. output current	250 mA for each output	250 mA for each output	250 mA	100 mA
Analog output	–	–	1..5 V	–
Switching logic	NO / NC (programmable)	NO / NC (programmable)	NO / NC (programmable)	NO; NC
Accuracy	± 2% FS	± 2% FS	± 2% FS	± 2% FS
Repeatability	± 0,2% FS	± 0,2% FS	± 0,2% FS	± 3% FS
MECHANICAL DATA				
Material (housing)	Plastic PC	Alloy anodized / Plastic ABS	Plastic PC	Plastic PC
Process connection	G1/8"; NPT1/8"	G1/8" female; G1/8" male; NPT1/8" male	G1/8"; NPT1/8"	M5 male; Tube 4 mm
Material (process connection)	Brass nickel-plated	Brass nickel-plated	Brass nickel-plated	Brass nickel-plated

VACUUM SWITCHES

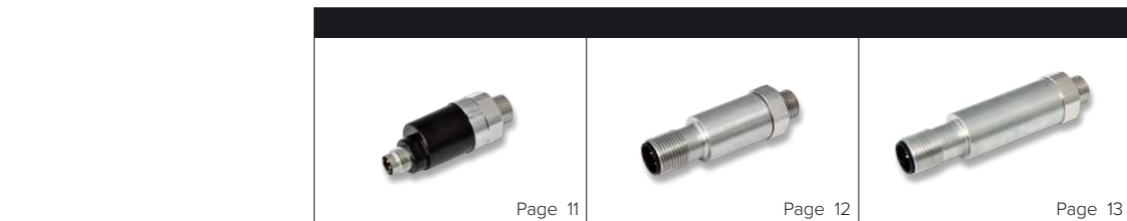

GENERAL DATA			
Pressure ranges (bar); (psi)	-1..0 / -1.1 / -1..10 / 0..10 / 0..12; -14,5..0/-14,5...14,5/-14,5..145/0..145/0..174	-1..0 / -1.1 / -1..10 / 0..10 / 0..12; -14,5..0/-14,5...14,5/-14,5..145/0..145/0..174	-1..0 / -1.1 / -1..10 / 0..10 / 0..12; -14,5..0/-14,5...14,5/-14,5..145/0..145/0..174
Signaling	–	–	–
Switching status display	–	–	–
IO-Link	●	●	●
IO-Link status display	–	–	–
Operating fluids	Filtered, dry or oiled air and non-corrosive gases	Filtered, dry or oiled air and non-corrosive gases	Filtered, dry or oiled air and non-corrosive gases
Degree of protection	IP65	IP65 (IP67 on request)	IP65 (IP67 on request)
PROGRAMMING OPTIONS			
Hysteresis / Window mode	● / ●	● / ●	● / ●
Switch point / Reset point	● / ●	● / ●	● / ●
Switching logic NO / NC	● / ●	● / ●	● / ●
Pressure unit	–	–	–
Switching delay ON	●	●	●
Switching delay OFF	●	●	●
Display rotatable by 180°	–	–	–
Display OFF	–	–	–
Diagnosis mode	–	–	–
Key lock	●	●	●
Reset to factory settings	●	●	●
ELECTRICAL DATA			
Electrical connection	M8, 4-pole	M12, 4-pole	M12, 4-pole
Operating voltage	9...30 VDC	9...30 VDC	9...30 VDC
intrinsic current consumption	< 20 mA	< 20 mA	< 25 mA
Short-circuit protection / Reverse polarity protection	● / ●	● / ●	● / ●
OUTPUT			
Switching output	1x PNP; 1x NPN (on request)	1x PNP; 1x NPN (on request)	2x PNP; 2x NPN (on request)
Max. output current	250 mA	250 mA	250 mA for each output
Analog output	–	–	–
Switching logic	NO / NC (programmable)	NO / NC (programmable)	NO / NC (programmable)
Accuracy	± 2% FS	± 2% FS	± 2% FS
Repeatability	± 0,2% FS	± 0,2% FS	± 0,2% FS
MECHANICAL DATA			
Material (housing)	Plastic PC	Stainless steel 1.4305	Stainless steel 1.4305
Process connection	G1/8"; NPT1/8"; Tube 6 mm	G1/8"; NPT1/8"; G1/4"; G3/8"; Push-in 6 mm	G1/8"; NPT1/8"; G1/4"; G3/8"; Push-in 6 mm
Material (process connection)	Brass nickel-plated; Plastic (Tube connection)	Brass nickel-plated; Stainless steel on request	Brass nickel-plated; Stainless steel on request

PRESSURE & VACUUM TRANSMITTERS

Electronic pressure and vacuum sensors with an analog voltage or current output

Pressure and vacuum transmitters measure the actual pressure or vacuum and convert the detected value into an analog signal. Depending on the requirements, pressure and vacuum transmitters can be equipped with a current output or a voltage output.

The MP-SENSOR pressure and vacuum sensors excel with outstanding quality and a compact and robust design. All transmitters are available with a current output of 4...20 mA or a voltage output of either 0...10V or 1...10 V and are designed for continuous industrial operation.

CASES OF APPLICATIONS

Due to the compact design of the housing and the very light weight, MP-SENSOR pressure and vacuum transmitters are extraordinarily suitable for handling and robotic applications. In many cases they ensure the safe reception of work pieces on vacuum grippers and robot end-of-arm tools, so that the handled components can be picked up and released reliably.

F09-T-K

Very compact and light-weight pressure and vacuum transmitter with an analog voltage or current output



YOUR ADVANTAGES

- + For small spaces: only Ø16 mm, only 45 mm in length
- + Ideal for pneumatic applications
- + Fast & easy installation: Tube connection possible
- + Integrated temperature compensation

CHARACTERISTICS

The F09-T-K pressure and vacuum transmitter converts the detected pressure value into an analog voltage (0...10 V / 1...10 V) or current (4...20 mA) signal. It perfectly qualifies for applications in the vacuum handling and pneumatic industry due to the compact design of the housing and the very light weight. The integrated temperature compensation and the high long-term stability together ensure a permanently accurate indicated value.

The analog output signal of F09-T-K pressure and vacuum transmitters can be used for almost any area of application by feeding an analog input of a control unit / a PLC.

VARIANTS / ORDER CODE

Process connection		Pressure range		Output signal	
G1/8"	01	bar	psi	4...20 mA	01
NPT1/8"	02	-1...0	-14.5...0	1...10 V**	02
Rohr 6 mm	03	-1...1	-14.5...14.5	0...10 V	03
Electrical connection					
M8, 4-polig	01	-1...10	-14.5...14.5		
M12, 4-polig	02	0...10	0...145		
		0...12	0...174		

** Not available for every pressure range

TECHNICAL DATA

Pressure ranges (bar); (psi)	-1...0 / -1...1 / -1...10 / 0...10 / 0...12 bar; -14,5...0 / -14,5...14,5 / -14,5...145 / 0...145 / 0...174 psi
Outputs	4... 20 mA / 1...10 V** / 0...10 V
Operating fluids	Filtered, dry or oiled air and noncorrosive gases
Mounting position	Any (port downwards when using oiled air)
Material (housing)	Plastic PC
Material (process connection)	Brass nickel-plated
Operating voltage	9...30 VDC (if current output) 14...30 VDC (if voltage output)
Accuracy	≤ 2% FS
Repeatability	< 0,2% FS p.a.
Weight	18 g
Electrical connection	M8 4-pole / M12 4-pole
Process connection	G1/8"; NPT1/8"; Tube 6 mm

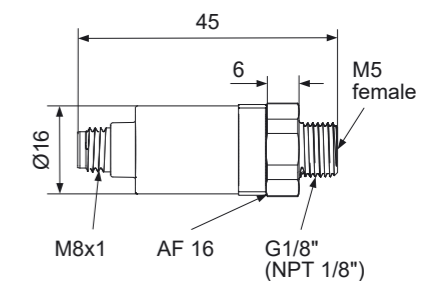

F09-T-M

Compact and durable pressure / vacuum transmitter in a stainless steel housing, with an analog voltage or current output



LABS_{free}

YOUR ADVANTAGES

- + For small spaces: only Ø 15.5 mm, only 67 mm in length
- + Very robust: stainless steel housing
- + Quick installation: available with Push-in process connection
- + LABS-free
- + Integrated temperature compensation

CHARACTERISTICS

The F09-T-M pressure and vacuum transmitter converts the detected pressure value into an analog voltage (0...10V / 1...10V) or current (4...20 mA) signal and excels with its stainless steel housing. Therefore it is especially suitable for harsh environments, such as pneumatic applications in robotics, handling or packaging. The integrated temperature compensation and the high long-term stability together ensure a permanently accurate indicated value.

 The proven and at "Fraunhofer Institute" according to the newest VDMA standard tested fact, that the sensor is LABS-free, makes it perfectly suitable for applications within lacquering system lines.

VARIANTS / ORDER CODE

Process connection		Pressure range		Output signal
G1/8"	01	bar	psi	4...20 mA 01
NPT1/8"	02	-1...0	-14.5...0	1...10 V** 02
G1/4"	04	-1...1	-14.5...14.5	0...10 V 03
G3/8"	05	-1...10	-14.5...145	
Push-in 6 mm	06	0...10	0...145	
		0...12	0...174	

** Not available for every pressure range

TECHNICAL DATA

Pressure ranges (bar); (psi)	-1...0 / -1...1 / -1...10 / 0...10 / 0...12 bar; -14,5...0 / -14,5...14,5 / -14,5...145 / 0...145 / 0...174 psi
Outputs	4... 20 mA / 1...10 V** / 0...10 V
Operating fluids	Filtered, dry or oiled air and noncorrosive gases
Mounting position	Any (port downwards when using oiled air)
Material (housing)	Stainless steel 1.4305
Material (process connection)	Brass nickel-plated
Operating voltage	9...30 VDC (if current output) 14...30 VDC (if voltage output)
Accuracy	≤ 2% FS
Repeatability	< 0,2% FS p.a.
Weight	28 g
Electrical connection	M12 4-pole
Process connection	G1/8"; NPT1/8"; G1/4"; G3/8"; Push-in 6 mm

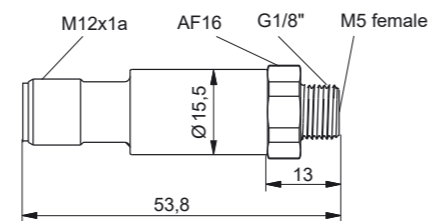

NOTES

INCLINATION SWITCHES

Robust, electronic inclination switches with precise MEMS sensor elements

The electronic inclination switches from MP-SENSOR are equipped with either transistor outputs or relay outputs. The moment a preset angle has been reached, the respective switching output will open or close. The highly accurate switches are designed for professional continuous operation and excel by highest quality and accuracy as well as through a robust, compact and an easy-to-assemble design. The sensor element and the electronics are protected against environmental influences excellently by a durable metal housing and the potting compound.

All MP-SENSOR inclination switches do not use any mercury at all and are temperature compensated. Angles are measured contactless by a modern, highly accurate Micro Electromechanical System (MEMS) with intelligent evaluation by a micro controller.

CASES OF APPLICATIONS

Inclination switches may be installed in stationary or mobile applications, in which it is necessary to measure and safely supervise any kind of an angle.

Typical cases of application of inclination switches (which are often also called crash sensors due to their case of operation) are tilt protection devices, lifting platforms, forklifts, cranes, excavators, agricultural machinery, truck trailers and also a lot of electric car charging stations. But inclination switches are also required and very useful in many more different areas such as mobile homes, yachts, off-road vehicles or wind power plants.

TO SEE ALL OUR INCLINATION SWITCHES AT A GLANCE, GO TO PAGE 24

DNS

Very easily programmable inclination switch with 4 independently adjustable transistor switching outputs



CHARACTERISTICS

The DNS inclination switches are equipped with a highly accurate MEMS sensor element. They are controlling actuators directly or indirectly over 4 independently adjustable transistor switching outputs (each supplied with 500 mA), without necessarily needing a control unit. The 4 switching angles can be assigned arbitrarily to the X- or Y-axis and the parameters of each output can be set independently with various adjustment options. The durable metal housing with the potting compound allow a wide range of applications in the industrial or outdoor stationary or mobile environment.

The DNS is very easily programmable on site by using its keys and display to access the menu. The display, 4 status LEDs and 4 cross-hair LEDs ensure fast visual feedback.

VARIANTS / ORDER CODE

Area of operation	Description	Product number
-10°...+10°	DNS-10-D2	50702010
-45°...+45°	DNS-45-D2	50702045
-85°...+85°	DNS-45-D2	50702085

YOUR ADVANTAGES

- + Very flexible: 4 independently adjustable switching angles
- + Highly accurate: high quality MEMS sensor element
- + Outdoor suitable: IP67 housing
- + Easily programmable: by keys and display through the menu

TECHNICAL DATA

Setting options for each output	Hysteresis / window mode, NO/NC, switch points, switching delay for ON and OFF
Operating voltage	9...30 VDC
Switching outputs	4x PNP, switching angles arbitrarily assignable to X- or Y-axis
Display	1 status LED for each output; 4 cross-hair LEDs; LED Display 3-digit (programming and display of angle)
Max. output current	500 mA for each output
Repeatability	0.03° (typ. at 0° C)
Temperature drift (at 0°C)	0.015°/°C for -20°...25°...60°C
Long-term stability	approx. 0.036° in 10 years (HTB test)
Display resolution	3 digits (0,1°)
Degree of protection	IP67
Material (housing)	Alloy, powder coated

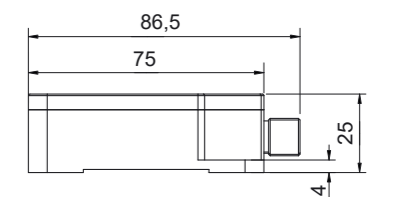
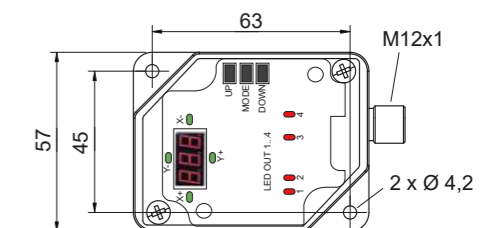

HNS-45-D2

Highly accurate and robust inclination switch with 4 PNP transistor switching outputs to monitor 2 axes



YOUR ADVANTAGES

- + 4x PNP transistor switching outputs
- + High accuracy: MEMS sensor element
- + Easy programming: Teaching with DIP switches
- + Small size
- + Robust metal housing IP67

CHARACTERISTICS

The HNS-45-D2 monitors the inclination of 2 axes, X and Y. There can be set an independent inclination angle on each of the two axes. The switching angles are automatically mirrored on the respective axis, so that by setting one angle, the same angle in the opposite direction of that axis (+/-) will also be monitored. The HNS is equipped with 4 separate transistor switching outputs for +X, -X, +Y and -Y. Due to its robust metal housing (IP67) and potted electronics, the switch excels in harsh operation environments.

The zero position can be adjusted afterwards, without reprogramming all the switching angles. The switch is equipped with a highly accurate MEMS sensor element.

VARIANTS / ORDER CODE

Area of operation	Description	Product number
-45°...+45°	HNS-45-D2	50200007

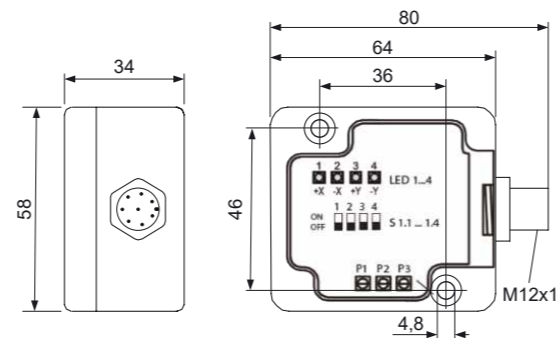

TECHNICAL DATA

Setting options	Switching angle X-axis (0.5°...45°)* Switching angle Y-axis (0.5°...45°)* Hysteresis (0.1°...2° via potentiometer) Inertia 5...0.2 sec Cut-off frequency 0.2 Hz
Operating voltage	9...30 VDC
Switching outputs	4x PNP transistor switching outputs
Display	4 LEDs: display of programming and status
Max. output current	500 mA for each output
Switching accuracy	±0,050° + 1% of inclination angle
Accuracy of calibration (25°C)	±0,050°
Ambient temperature	Operation: -25°...+80°C
Degree of protection	IP67
Material (housing)	Alloy, powder coated

HNS-45-D2-R

Highly accurate and robust inclination switch with merged relay output to monitor 2 axes



YOUR ADVANTAGES

- + 1 potential-free relay output (2 A load)
- + High accuracy: MEMS sensor element
- + NO/NC function through toggle switch
- + Safety function: signal when power failure
- + Small, robust metal housing IP67

CHARACTERISTICS

The HNS-45-D2-R monitors the inclination of 2 axes, X and Y. There can be set an independent inclination angle on each of the two axes. The switching angles are automatically mirrored on the respective axis, so that by setting one angle, the same angle in the opposite direction of that axis (+/-) will also be monitored. Due to its robust metal housing (IP67) and potted electronics, the switch excels in harsh operation environments, especially when mounted to mobile work machines or stationary outdoor equipment.

The merged relay output drops down when reaching a set inclination angle or in case of a power failure (safety function). The zero position can be adjusted afterwards, without reprogramming all the switching angles.

VARIANTS / ORDER CODE

Area of operation	Description	Product number
-45°...+45°	HNS-45-D2-R	50210008

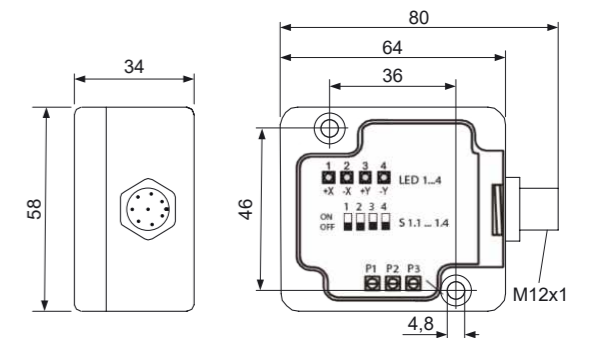

TECHNICAL DATA

Setting options	Switching angle X-axis (0.5°...45°)* Switching angle Y-axis (0.5°...45°)* Hysteresis (0.1°...2° via potentiometer) Inertia 5...0.2 sec Cut-off frequency 0.2 Hz
Operating voltage	9...30 VDC
Switching outputs	1x potential-free relay output, works as toggle switch
Display	4 LEDs: display of programming and status
Max. output current	Relay-output 2 A
Switching accuracy	±0,050° + 1% of inclination angle
Accuracy of calibration (25°C)	±0,050°
Ambient temperature	Operation: -25°...+80°C
Degree of protection	IP67
Material (housing)	Alloy, powder coated

VACUUM EJECTORS

Economic, robust and reliable ejectors in various sizes and designs

MP-Sensor offers various vacuum ejectors in many different designs and performance levels. Besides a considerably wide range of standard ejectors, MP-Sensor also provides cutting-edge innovations, such as multi-circuit ejectors, booster release ejectors and air saving ejectors. Extremely versatile to use are our multifunctional AUTOVAC MFE ejectors.

Our vacuum generators work according to the venturi principle and are explicitly air saving. There are no moving parts, therefore the ejectors are very robust and long-lasting. The ejectors impress by small sizes and a high vacuum level despite a very low air consumption.

CASES OF APPLICATIONS

Our ejectors can be used anywhere, vacuum is needed and compressed air is available.

Typical cases of operation are industrial robot applications such as automatic feedings in the automotive industry, handling systems and sheet metal processing. They are also often used in various areas of the packaging industry, pick-and place production lines, vacuum handling and gripping solutions, and in a lot of areas within the process industry.

MULTI CIRCUIT

Ejectors with 4, 5, 6 or 8 independent vacuum circuits - clearly arranged, cost-effective and compact

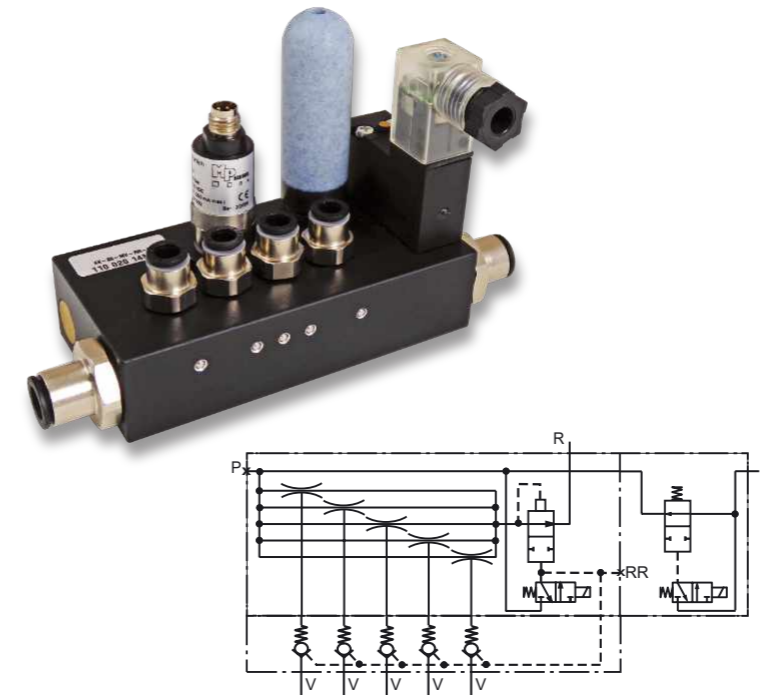

YOUR ADVANTAGES

- + Fast and simple installation
- + 4 to 8 independent vacuum circuits
- + AMS monitoring system: only 1 sensor for vacuum monitoring of all circuits
- + Increased safety: also possible with vacuum holding valve
- + Economical: electronically operated compressed air supply valve possible
- + Cost-effective: fewer components save on assembly and purchase

CHARACTERISTICS

The MULTI CIRCUIT ejectors are available with up to 8 independent vacuum circuits, which are combined in a small housing in a very space-saving and very compact way. This enables a very quick and clear installation, simplifies assembly and saves a lot of time. Compared to the use of conventional ejectors, much fewer components (tubes, cables, fittings, sensors, system inputs) are required, thus reducing the purchase costs.

The blow off process for all vacuum circuits is started centrally via a common signal. Both, air operated blow off as well as solenoid operated blow off is possible. When several MULTI CIRCUIT ejectors are connected in series, a combination as well as a master/slave function is possible.

Even if not all suction cups are in contact with the object (e.g. differently shaped parts), the remaining suction cups still generate vacuum and the object can be lifted. The AMS system is able to monitor all vacuum circuits using just one sensor.

VARIANTS / ORDER CODE

		110	XXX	XX	XXXX
		↑	↑	↑	↑
Dimension					
MULTI 010	010				
MULTI 020	020				
MULTI 030	030				
Number of Circuits					
4 Circuits	14				
5 Circuits	15				
6 Circuits	16				
8 Circuits	18				
Performance					
Air operated blow off					
Solenoid operated					M
AMS Monitoring System					S
Vacuum holding valves					B
Supply valve NC					C
Supply valve NO					O

BOOSTER RELEASE

Ejectors for applications with extremely fast cycles

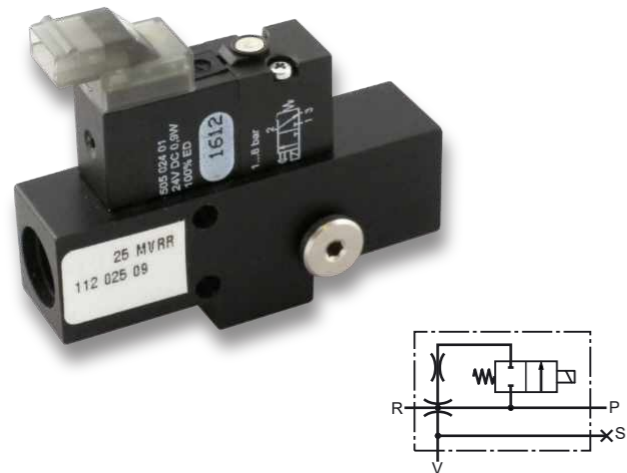

CHARACTERISTICS

The BOOSTER RELEASE ejectors are equipped with a unique, patented, extremely fast blow off system, ideal for applications with very short cycle times.

For blow off, a jet nozzle is activated by a solenoid valve, which redirects the compressed air flow to the vacuum connection. In addition to the compressed air flow through the pressure connection and the jet nozzle, air is now sucked in from the environment through the exhaust. This additional environmental air flow decreases as the vacuum level decreases. Thus, the object is released very quickly but still gently and in a controlled manner.

When installed locally directly on the vacuum lifter, the low weight and compact design allow the ejector to be used as a suction cup mounting. The easy installation and small tube dimensions result in low installation costs.

VARIANTS / ORDER CODE

Designation	Max. vacuum flow NI/min.	Connecting threads P / V / R	Air consumption NI/min.	Evacuation/ Blow off time (1 litre)		Product No.
				0=>50% / 50%=>0 Sec.	0=>70% / 70%=>0 Sec.	
25 MV-BR	26	G1/8	30	1.80 / 0.50	3.90 / 0.61	11202509
60 MV-BR	65	G1/4	75	0.68 / 0.17	1.47 / 0.22	11206009

YOUR ADVANTAGES

- + Extremely fast: for very short cycles
- + Very compact and light: ideal for installation directly on the suction cup
- + Ejector can be used as suction cup mounting
- + Very robust and durable: designed for up to 100 million operation cycles

TECHNICAL INFORMATION

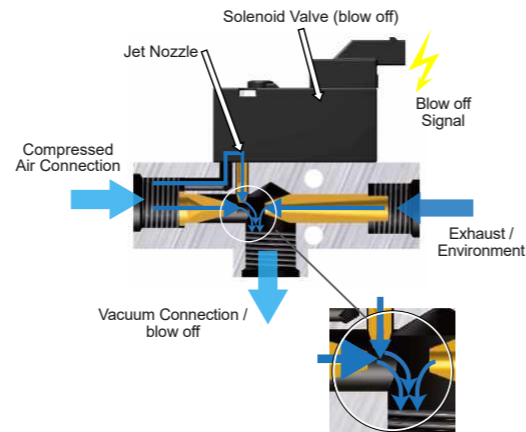

Blow off =
 + Compressed air through ejector
 + Compressed air solenoid valve (jet nozzle)
 + Air withdrawn ("exhaust")

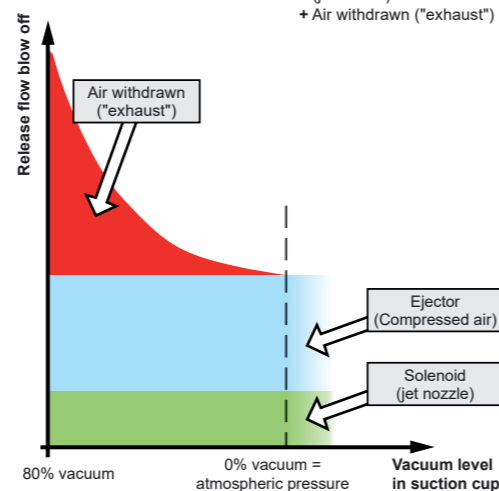

2BV AIR SAVE

Vacuum ejector with automatic air saving function - allows approx. 95% energy savings

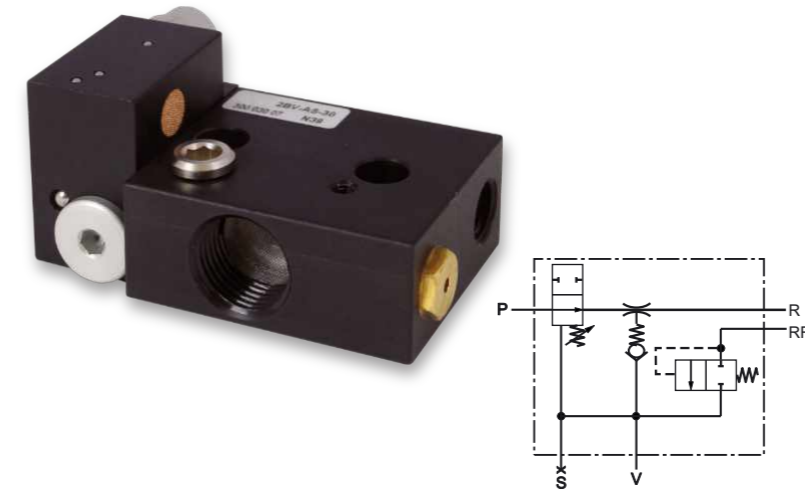

CHARACTERISTICS

2BV AIR SAVE ejectors are equipped with an integrated vacuum control circuit. When the factory-set upper vacuum level of -0.75 bar is reached, it shuts off the air supply. If the vacuum drops to the lower set value of -0.65 bar due to leakage, the air supply is automatically restarted. This enables a significant compressed air saving of approx. 95%! The lower vacuum threshold value can be very easily changed by $\pm 10\%$ via an adjusting screw on the ejector.

The object to be transported is quickly and safely released by a blow off impulse. The blow off valve already opens from 0.5 bar. The 2BV AIR SAVE ejector also has a measuring connection for vacuum monitoring by an external sensor.

Due to the integrated full pneumatic vacuum control circuit no external control system is required. The ejector can be installed quickly and easily. This saves additional money on purchase and installation.

VARIANTS / ORDER CODE

Designation	Max. vacuum flow NI/min.	Connecting threads				Air consumption NI/min.	Evacuation time * Sec.	Product No.
		P	V	R	RR			
2BV-AS-20	12.8	G1/4	G1/2	G1/4	M5	0-20	9	30002007
2BV-AS-30	17.3	G1/4	G1/2	G1/4	M5	0-30	6	30003007
2BV-AS-40	27.6	G1/4	G1/2	G1/4	M5	0-40	4.5	30004007
2BV-AS-60	42.6	G1/4	G1/2	G1/4	M5	0-60	3	30006007
2BV-AS-100	64.0	G1/4	G1/2	G1/2	M5	0-100	2	30010007
2BV-AS-150	96.0	G1/4	G1/2	G1/2	M5	0-150	1.2	30015007

* Time to evacuate 1 litre air from atmospheric pressure to 75% vacuum.

YOUR ADVANTAGES

- + Automatic air-saving function: saves over 95% of compressed air
- + Integrated vacuum control circuit: no external control system required
- + Integrated holding valve and blow off valve: double safety against unintentional release

TECHNICAL INFORMATION

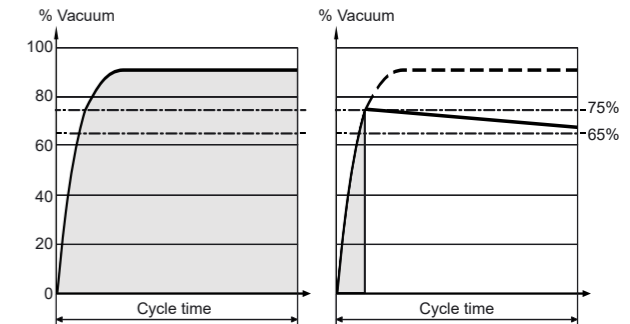

Case example:

In 0.36 seconds a volume of 0.05 litres is to be evacuated to 75% vacuum. An ejector of size 30 is selected. With a cycle time of 10 seconds and a standard ejector, the compressed air consumption is 5 litres per cycle. With a 2BV 30 AIR SAVE ejector it is only 0.18 litres. This means a compressed air saving of over 96%!

AUTOVAC MFE

Programmable multifunction ejector with automatic air-saving function - available in 4 sizes

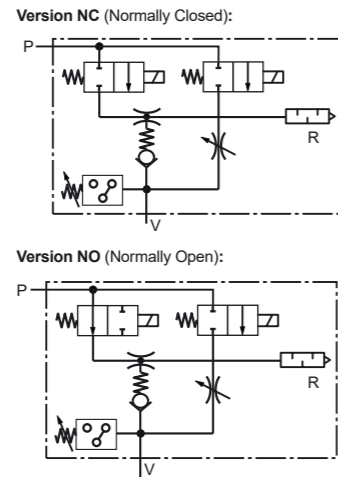

YOUR ADVANTAGES

- + Variably configurable: programmable vacuum and blow off functions
- + Increased process safety: preventive maintenance functions
- + Integrated air-saving automatic
- + Higher safety in case of pressure drop: built-in holding valve

CHARACTERISTICS

The AUTOVAC MFE is a smart vacuum generator that has been specially designed to meet the requirements of Industry 4.0. The intelligent plug-and-play ejector can be used very flexibly and, with its integrated, programmable automatic air-saving function, offers an air-saving potential of more than 95% (depending on the application). The built-in holding valve delays the release of the object in case of pressure drop. The MFE ejectors are available in 4 sizes and in the versions NC (Normally Closed) and NO (Normally Open).

By means of various feedback options, wear and tear, e.g. of suction cups, hoses or connections, can be detected at an early stage, even before the system fails. Expensive downtimes can thus be avoided.

VARIANTS / ORDER CODE

Size	MFE - XXX H - X X X	Silencer
MFE 100	100	with 0
MFE 200	200	without 1
MFE 300	300	
MFE 400	400	
Function	Connection / Version *	
NC	Plug M12, 5-pin C	
NO	Plug M12, 5-pin D	
	Plug M12, 8-pin S	

* See table on the right

TECHNICAL DATA

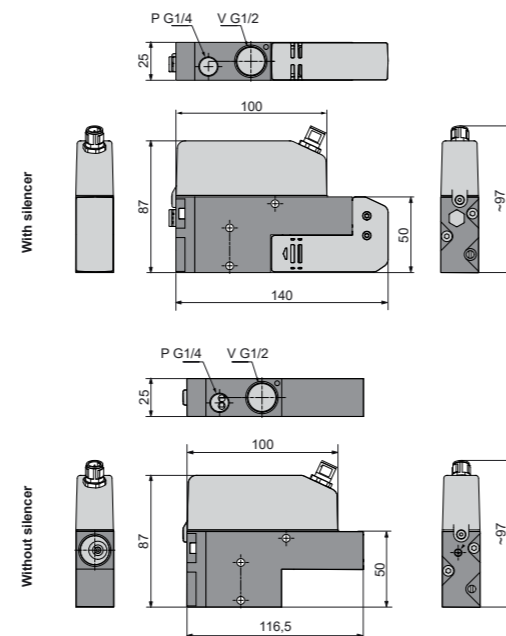

Function	Version C	Version D	Version S
Time set blow off	•	•	•
Adaptive blow off	•	•	•
Manual / External blow off	-	•	•
Feedback Vacuum OK / blow off OK	•	•	•
Feedback Predictive Maintenance*	•	-	•

*Feedback when deviations in vacuum generation, e.g. when leakage occur.

BASE EJECTORS

Basic, cost-effective standard vacuum ejectors

MINI

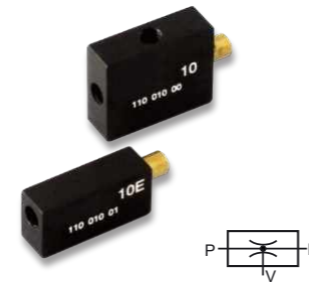

INLINE



ORIGINAL

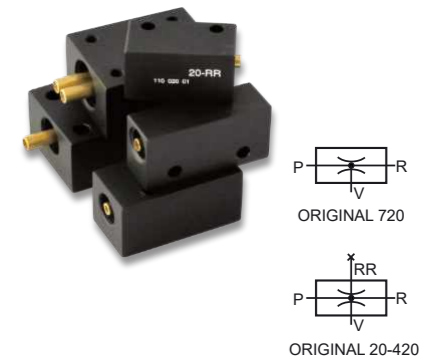

YOUR ADVANTAGES

- + Extremely small and light: only 8/13 g, 30 mm short
- + Very fast reaction: primary nozzle Ø 0.5 mm
- + Robust: aluminium housing, no moving parts
- + quick and easy installation

CHARACTERISTICS

The very small and light MINI ejectors are used where small and light objects are handled and very tiny installation dimensions are important. They are particularly used in the production of electronic components.

With a supply pressure of only 4 bar the MINI ejectors can generate a high vacuum of more than 85%. They are available with and without mounting thread.

YOUR ADVANTAGES

- + Very compact and light: Ø 16 mm, 12/15 g lightweight
- + Quick and easy installation: push-in connections
- + Robust: no moving parts
- + Versions for high vacuum level or high vacuum flow

CHARACTERISTICS

The INLINE ejectors are available in two sizes, each with nozzles for a high air flow (porous materials) or a high vacuum level (tight materials). With their low weight and compact housing, they are suitable for the electrical industry, among others.

For quick and easy installation, both the compressed air connection and the vacuum connection are available with either a push-in fitting or a G1/8" thread.

YOUR ADVANTAGES

- + Either for controlled blow off or vacuum sensor: RR connection
- + Robust: aluminium housing, no moving parts
- + Compact, light and efficient: reduced to the essentials

CHARACTERISTICS

The ORIGINAL ejectors generate a high vacuum of more than 85% already at 4 bar compressed air supply. The very low supply pressure required made these ejectors very efficient in terms of energy consumption.

The RR connection can be used for controlled blow off of the object or to connect a vacuum sensor. If the RR connection is not required, it can be closed with the plug supplied.

SOLENOID OPERATED EJECTORS

The vacuum generation and/or blow off are operated by solenoid valves

MV / MV-MV

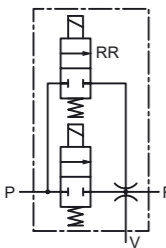
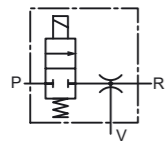

CHARACTERISTICS

The MV and MV-MV ejectors made of anodised aluminium have a simplified and compact design. Thanks to two through-holes, they can be mounted easily and quickly.

The MV and MV-MV ejectors each have a solenoid valve for electronically operated vacuum generation. The MV-MV ejectors have an additional solenoid valve for electronically operated blow off.

With a suction cup mounted directly on the ejector you get very short reaction times.

We recommend the cable plugs equipped with an LED display for the electrical connection (see accessories page 41). This gives you a quick overview and makes troubleshooting easier.

YOUR ADVANTAGES

- + Electrically operated vacuum generation: solenoid valve
- + Electrically operated, controlled blow off (MV-MV): second solenoid valve
- + Very efficient: high vacuum over 85% at 5 bar compressed air supply
- + Low weight: only 185 - 260 g

VARIANTS / ORDER CODE

Designation	Max. vacuum flow NI/min.	Connecting threads			Air consumption NI/min.	Evacuation time * Sek.	Product No.
		P	V	R			
10 MV	7.5	G1/4"	G1/4"	G1/4"	10	18	11201004
20 MV	14.2	G1/4"	G1/4"	G1/4"	20	9	11202004
30 MV	20.1	G1/4"	G1/4"	G1/4"	30	6	11203004
40 MV	28.0	G1/4"	G1/4"	G1/4"	40	4.5	11204004
60 MV	44.0	G1/4"	G3/8"	G1/4"	60	3	11206004
10 MV-MV	7.5	G1/4"	G1/4"	G1/4"	10	18	11201005
20 MV-MV	14.2	G1/4"	G1/4"	G1/4"	20	9	11202005
30 MV-MV	20.1	G1/4"	G1/4"	G1/4"	30	6	11203005
40 MV-MV	28.0	G1/4"	G1/4"	G1/4"	40	4.5	11204005

* Time to evacuate 1 litre air from atmospheric pressure to 75% vacuum.

EJECTORS WITH VACUUM HOLDING VALVE

High compressed air saving potential in combination with high safety in case of pressure loss

2BV

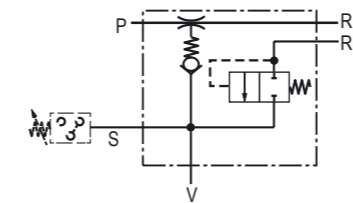

CHARACTERISTICS

The compact, lightweight 2BV ejectors are ideal for handling non-porous materials such as metal or glass. Energy savings of more than 95% are possible when using an appropriate control system.

The blow off valve already opens from 0.5 bar, so several 2BV ejectors can be operated with the same blow off pulse.

YOUR ADVANTAGES

- + Double safety against unwanted release: Integrated check valve and blow off valve
- + > 95% air saving potential: integrated holding valve
- + Vacuum monitoring: Connection for sensor

AUTOVAC

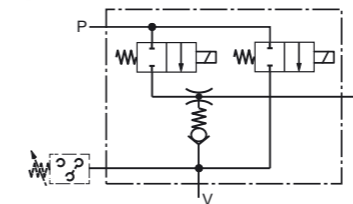

CHARACTERISTICS

An external control system with vacuum sensor shuts off the compressed air supply when the required vacuum level is reached. The holding valve closes and the vacuum sensor monitors the maximum and minimum vacuum level. This reduces compressed air consumption to a minimum. The blow off is activated via the second solenoid valve.

YOUR ADVANTAGES

- + Electronic vacuum and blow off control: 2 solenoid valves
- + more than 95% air saving potential: integrated holding valve
- + Vacuum monitoring: Connection for sensor

VARIANTS / ORDER CODE

Designation	Max. vacuum flow NI/min.	Connecting threads				Air consumption NI/min.	Evacuation time * Sec.	Product No.
		P	V	R	RR			
2BV-20	12.8	G1/4"	G1/2"	G1/4"	M5	20	9	11002006
2BV-30	17.3	G1/4"	G1/2"	G1/4"	M5	30	6	11003006
2BV-40	27.6	G1/4"	G1/2"	G1/4"	M5	40	4.5	11004006
2BV-60	42.6	G1/4"	G1/2"	G1/4"	M5	60	3	11006006
2BV-100	64.0	G1/4"	G1/2"	G1/2"	M5	100	2	11010006
2BV-150	96.0	G1/4"	G1/2"	G1/2"	M5	150	1.2	11015006
AUTOVAC 60; 24 VDC; 4.5 W	42.6	G1/4"	G1/2"	G4/4"	-	60	3	11206007
AUTOVAC 180; 24 VDC; 4.5 W	105.0	G1/4"	G1/2"	G3/8"	-	180	1	11218107
AUTOVAC 360; 24 VDC; 4.5 W	168.0	G1/4"	G1/2"	G1/2"	-	360	0.5	11236407

* Time to evacuate 1 litre air from atmospheric pressure to 75% vacuum.

ACCESSORIES

Relevant accessories, perfectly matching the product portfolio of MP-Sensor

With matching accessories you will be able to fully utilize the potential of our products. To ensure a quick and simple installation, MP-Sensor provides a wide range of useful accessories. They are tested and exactly tailored to our sensors, switches and ejectors. Through competitive prices, high quality and many variations we can be a perfect one-source supplier for your need. This will help you to increase productivity and save time and money.

For the electrical connection you may chose between various types, lengths and variations of connection cables to meet the requirements of your application. Your fluid port is incompatible to the fluid connection of a product? Various different adapters can help you to install the sensor. We also help you with different kind of mounting brackets or installation kits to arrange our products at your mounting location.

CONNECTION TECHNOLOGY

Matching connection cables for our pressure and vacuum sensors and our inclination switches.

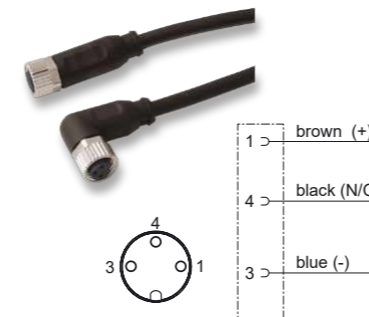

M8 FEMALE 3-POLE

M8 connector cable with open line end.
Suitable for VS11.

cable	design	straight	90°	straight with LED	90° with LED
PUR/PVC shielded		–	–	–	–
PUR/PVC not shielded		3 m, 5 m	3 m, 5 m	–	–

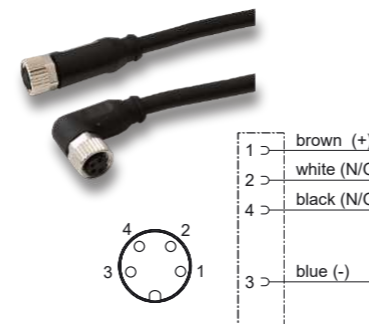

M8 FEMALE 4-POLE

M8 connector cable with open line end.
Suitable for PICO-02, NANO-02, FEMTO, F08-T-K, F09-T-K.

cable	design	straight	90°	straight with LED	90° with LED
PUR/PVC shielded		3 m, 5 m, 10 m	3 m, 5 m, 10 m	–	–
PUR/PVC not shielded		3 m, 10 m	3 m, 10 m	–	–
PVC not shielded		5 m	5 m	–	–

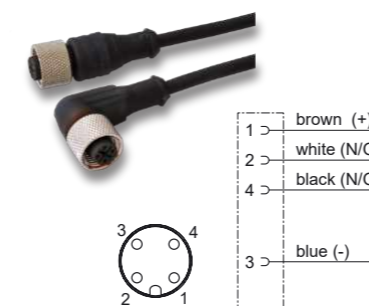

M12 FEMALE 4-POLE

M12 connector cable with open line end.
Suitable for F08-M1, F08-M2, F08-T-K, PICO-02, F09-T-M.

cable	design	straight	90°	straight with LED	90° with LED
PUR/PVC shielded		5 m, 10 m	5 m, 10 m	–	–
PUR/PVC not shielded		3 m, 5 m, 10 m	3 m, 5 m, 10 m	5 m, 10 m	5 m, 10 m

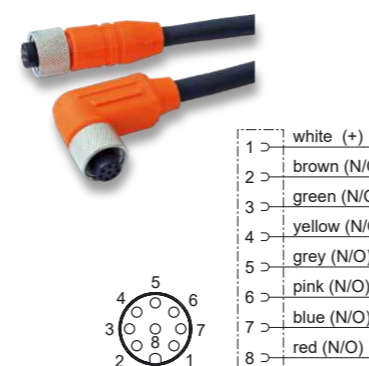

M12 FEMALE 8-POLE

M12 connector cable with open line end.
Suitable for inclination switches DNS, HNS-45-D2 and HNS-45-D2-R.

cable	design	straight	90°	straight with LED	90° with LED
PUR/PVC shielded		2 m, 5 m, 10 m	2 m, 5 m, 10 m	–	–
PUR/PVC not shielded		–	–	–	–

MOUNTING ACCESSORIES

Perfectly suitable for our pressure and vacuum sensors



G1/8" ADAPTER FLANGE

Adapter flange for the mounting of sensors with a G1/8" male fluid port. G1/8" male, including sealing gasket. Suitable for PICO, FEMTO, F08-K and F09-K.

(P/N 8041730)



G1/8" ADAPTER + BRACKET

Set consisting of G1/8" adapter flange and a bracket with mounting screws. For easy installation of our sensors PICO, FEMTO, F08-K and F09-K with G1/8" male fluid port.

(P/N 8040610)



BRACKET + PUSH-IN ADAPTER

Set for easy mounting and easy installation and by retrofitting a push-in hose connector. Suitable for PICO, FEMTO, F08-K and F09-K with a G1/8" fluid port. Following variations are available:

- + for 4 mm hose (P/N 8038574)
- + for 6 mm hose (P/N 8038576)
- + for 8 mm hose (P/N 8038578)



CLAMP MOUNTING

Simple clamp mounting made of plastic to easily clip our sensors to any place. Suitable for PICO, FEMTO, F08-K, F08-M1, F08-M2, F09-K and F09-M.

(P/N 1026373)



CLAMP MOUNTING + HAT RAIL CLIP

Set consisting of clamp mounting and hat rail clip. To easily install our sensors within control cabinets with top hat rails. Suitable for PICO, FEMTO, F08-K, F08-M1, F08-M2, F09-K and F09-M.

(P/N 8040532)



NANO MOUNTING BRACKET

Bracket including fasteners to easily install our NANO vacuum and pressure switch anywhere.

(P/N 8040534)

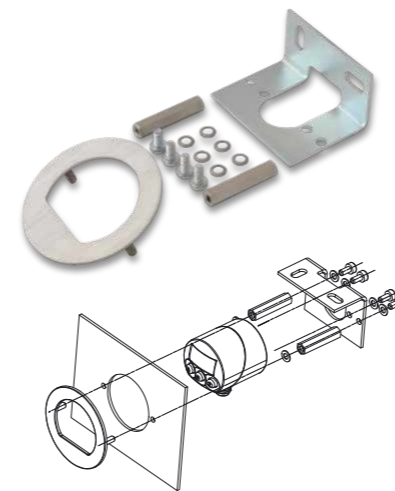

NANO INSTALLATION KIT

Installation-kit for front panel installation of our NANO vacuum and pressure switch. Including an elegant metal cover.

(P/N 8040570)

REDUCERS / DOUBLE NIPPLES

Suited for our vacuum and pressure sensors.

PUSH-IN REDUCERS



Adapter suiting the sensors with a G1/8" fluid port PICO, FEMTO, F08-K and F09-K, to retrofit them with a push-in hose connector.

Following variations are available:

- + G1/8" female / push-in, 4 mm hose (P/N 8038564)
- + G1/8" female / push-in, 6 mm hose (P/N 8038566)
- + G1/8" female / push-in, 8 mm hose (P/N 8038568)

REDUCERS



Adapter to change the thread size or type of a fluid port.

Following variations are available:

- + G1/8" female / G1/4" male (P/N 8038614)
- + G1/4" female / G1/2" male (P/N 9017783)

DOUBLE NIPPLE



Adapter to change the thread size or type of the fluid port of our NANO vacuum and pressure switch with a G1/8" female port.

Following variations are available:

- + G1/8" male / G1/8" male (P/N 8038563)
- + G1/8" male / NPT1/8" male (P/N 8038620)
- + G1/8" male / G1/4" male (P/N 8038627)

RELAY BOXES / PULSE STRETCHERS

To adjust the transistor switching outputs to your requirements

RELAY BOXES



CHARACTERISTICS

The relay boxes enable a potential free integration of our sensors with PNP transistor switching outputs into an electronic control system.

By means of the built-in changeover contacts you can realize NO or NC functionality. Following variations are available:

- + RB-2-2 with 2 inputs and 2 outputs (P/N 50100902)
- + RB-4-4 with 4 inputs and 4 outputs (P/N 50100904)

YOUR ADVANTAGES

- + Potential free relay changeover contacts
- + Load currents of up to 5A for each output
- + Robust metal housing
- + Protection class IP65

PULSE STRETCHER MP-IV2.0



CHARACTERISTICS

If the output signal of a sensor is too short for a specific application, this impulse stretcher helps by increasing the length of the signal. It will detect impulses as short as 1.5 ms and stretch them by a freely adjustable range between 2 ms and 2 s.

The MP-IV2.0 is suitable for PNP as well as for NPN transistor switching outputs and can be operated in two different modes: Either the incoming impulse is stretched by a length between 2 ms and 2 s (impulse triggered), or the output signal equates to the fixed set time span between 2 ms and 2 s (edge triggered).

(P/N 11854310)

YOUR ADVANTAGES

- + Suitable for PNP or NPN sensor outputs
- + 2 operating modes: Impulse triggered or edge triggered
- + Flexible: adjustable and anti-valent output signals

EJECTOR ACCESSORIES

Exactly suitable for our vacuum ejectors

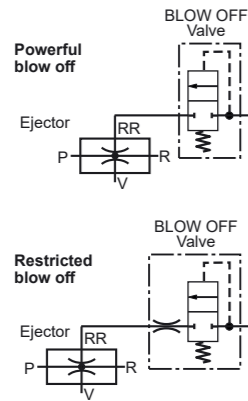

BLOW OFF Valve

The blow off valve is connected to the Rapid Release port RR. It prevents vacuum leakage in the case of tubing damage, thus increasing safety. In addition, the response time is reduced, as the tube does not need to be evacuated when creating vacuum.

Since the blow off valve already opens at a signal pressure of 0.5 bar, several valves can be connected to the same blow off signal. When using several valves with a common blow off signal, the restricted version must be used.

Designation	Product No.
BLOW OFF Valve, Powerful blow off	21001800
BLOW OFF Valve, Restricted blow off	21001801

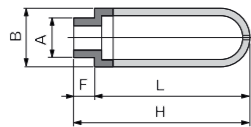

SILENCER

Silencer with a very good sound dampening effect. A drilled hole reduces the risk of clogging by particles in the exhaust air.

Designation	Product No.	A	B (mm)	F (mm)	L (mm)	H (mm)
Silencer-B G1/8"	62001810	G1/8"	12.5	5.5	28.5	34
Silencer-B G1/4"	62001410	G1/4"	15.5	7	35.5	42.5
Silencer-B G3/8"	62003810	G3/8"	18.5	11.5	56	67.5
Silencer-B G1/2"	62001210	G1/2"	23.3	11	66.5	77.5
Silencer-B G1"	62010010	G1"	49	21	140	161

MULTIPLE MANIFOLDS FOR MFE EJECTORS



The multiple manifolds fit all sizes of MFE ejectors. It allows to mount 2-5 ejectors easily, quickly and compactly. To prepare for a potential increase in the number of ejectors on the multiple manifolds, a blind plate is available to reserve one position for this purpose. The manifold can be connected to the air supply (G3/8") on either side.

Multiple manifold	Product No.
for 2 MFE-Ejectors	41000002*
for 3 MFE-Ejectors	41000003*
for 4 MFE-Ejectors	41000004*
for 5 MFE-Ejectors	41000005*
Blind plate	41000000

* Screws and seals are included.



COMPRESSED AIR SUPPLY VALVE MULTI

The air flow of the air supply valve MULTI is sufficient to supply a number of MULTI CIRCUIT ejectors in series (24 nozzles size 10 / 12 nozzles size 20 / 8 nozzles size 30). It is only intended to be used in combination with solenoid operated blow off.

Designation	Product No.
MULTI, Version NC (normally closed)	48200000
MULTI, Version NO (normally open)	48200001



CABLE CONNECTOR FOR EJECTORS 10 MV, 20 MV, 30 MV, 40 MV

Cable connector with LED and surge protection (EN175301-803 Typ B, ISO 6952). (P/N 59000001)



CABLE CONNECTOR FOR EJECTORS 60 MV + AUTOVAC

Cable connector with LED and surge protection (EN175301-803 Typ A, ISO 4400). (P/N 59002400)



CABLE CONNECTOR FOR MULTI CIRCUIT + BOOSTER RELEASE 60 MV

Cable connector with LED and surge protection (EN175301-803, ISO 6952). (P/N 59002402)



CABLE FOR BOOSTER RELEASE 25 MV

Connector cable with open line end. (P/N 59000130)



REDUCER G1/8" MALE - M5 FEMALE

For mounting the vacuum switch VS11 on ejectors with G1/8" connection. (P/N 24111805)



Online

info@norstat.com
www.norstat.com

Address

NORSTAT Inc.

300 Roundhill Dr. Rockaway,
NJ 07866

Phone & Fax

T +1-973-586-2500
F +1-973-586-1590
